

EASY ROOTER PARTS LIST

ITEM NO.	CATALOG NO.	DESCRIPTION	ITEM NO.	CATALOG NO.	DESCRIPTION
165055	ER-100-1	Frame Complete (Serial #1800 & Up)	136070	ER-207-B	Foot Pedal & Hose
165075	ER-101-1	Frame Only (Serial #1800 & Up)	165813	ER-207-C	Hose Clamp (2)
165080	ER-101-1-A	Handle Socket	136060	ER-207-D	Foot Pedal
165085	ER-101-1-B	Handle Hinge Bolt	136080	ER-207-E	Power Switch Diaphragm
171205	ER-101-1-C	Rubber Leg Tip (2)	136050	ER-207-F	Air Hose
171021	ER-101-1-D	Rubber Cord Wrap Tip (2)	136210	ER-207-G-R	Momentary Contact Reverse Switch Only (Red)
165130	ER-102	10" Rubber Wheel (1)	165818	ER-207-H	Rubber Switch Boot
165160	ER-103	Axle	171279	ER-207-K	Switch Guard
165170	ER-103-A	Locknuts (2)	165850	ER-208	V-Belt (52") (Thru Serial #ER85118)
165172	ER-103-B	Spacer Washers (4)	136190	ER-208-1	V-Belt (53") (Thru Serial #ER85119 & Up)
171205	ER-101-C	Wheel Bushing (2)	165880	ER-209	Motor Support Spring
165190	ER-104	Wheel Spacer	165941	ER-211-1	Belt Guard for AO Smith Motor (Serial #4346 & Up)
165205	ER-105-1	Handle w/Knobs (Serial #1800 & Up)	165945	ER-211-2	Belt Guard w/Slot for Stud
165208	ER-105-1-A	Handle Locking Knob (2) (Serial #1800 & Up)	165950	ER-212	Motor Support Bracket w/Guide Screws
165300	ER-108	Drum Support Shaft	165955	ER-212-A	Guide Screws (2)
165330	ER-109	Bronze Thrust Washer	165960	ER-213	Nuts, Bolts, Washers (4)
165360	ER-110	Felt Washer	166005	ER-300-1	Large Open Cage (for 3/4" & 5/8" Cables)
165390	ER-111	Drum Hub Retaining Washer	166060	ER-302	Drum Hub w/Bearings
165420	ER-112	Drum Shaft Retaining Bolt for Large & Small Drum	166070	ER-302-A	Drum Hub Bearings (2)
165430	ER-113	High Collar Lock Washer	166080	ER-302-B	Retaining Ring (2)
165209	ER-120	Tool Holder	166081	ER-302-C	Bolts & Lock Washers (12)
171202	ER-121	Screws & Washers for Tool Holder (2)	166120	ER-303	Cable Locking Thumb Screw
165608	ER-201-1	1/3 hp Motor Complete w/GFCI, Air Foot Switch & Reverse Switch Assembly	166125	ER-303-1	Quick-Grip Chuck Assembly
165625	ER-201-C	Knob for Belt Guard	166126	ER-303-1-A	Grip Knob
165710	ER-204-1	Slip Clutch	166127	ER-303-1-B	Quick-Grip Body
165720	ER-204-A	Fixed Pulley Half	166253	ER-303-1-E	Set Screws (2)
165730	ER-204-B	Spacer	166254	ER-303-1-F	Retaining Ring
165740	ER-204-C	Moveable Pulley Half	166131	ER-303-1-G	Set of Grippers (3)
165750	ER-204-D	Spring	166130	ER-310	Drum Connecting Cable w/ Nut, Screw, & Lock Washer
165760	ER-204-E	Thrust Washer	166250	ER-353	Cable Locking Thumb Screw
165770	ER-204-F	Thrust Bearing	166255	ER-354	Small Drum Retaining Bolt (Thru Serial #1799)
165780	ER-204-G	Retaining Ring	132210	ER-DECAL	Set of Safety Decals
136000	ER-205	20' Power Cord w/Plug & GFCI	132340	ER-DVD	Instructional DVD
165810	ER-207	Air Foot Switch & Reverse Switch (Serial #1938 & Up)	166305	ERHOI	Condensed Operating Instructions (Instructions w/Chain & Fittings, Connector, & Screw)
165811	ER-207-A	Box Only w/Cover & Screws	166270	EROI	Complete Operating Instructions

EASY ROOTER SCHEMATIC DIAGRAM

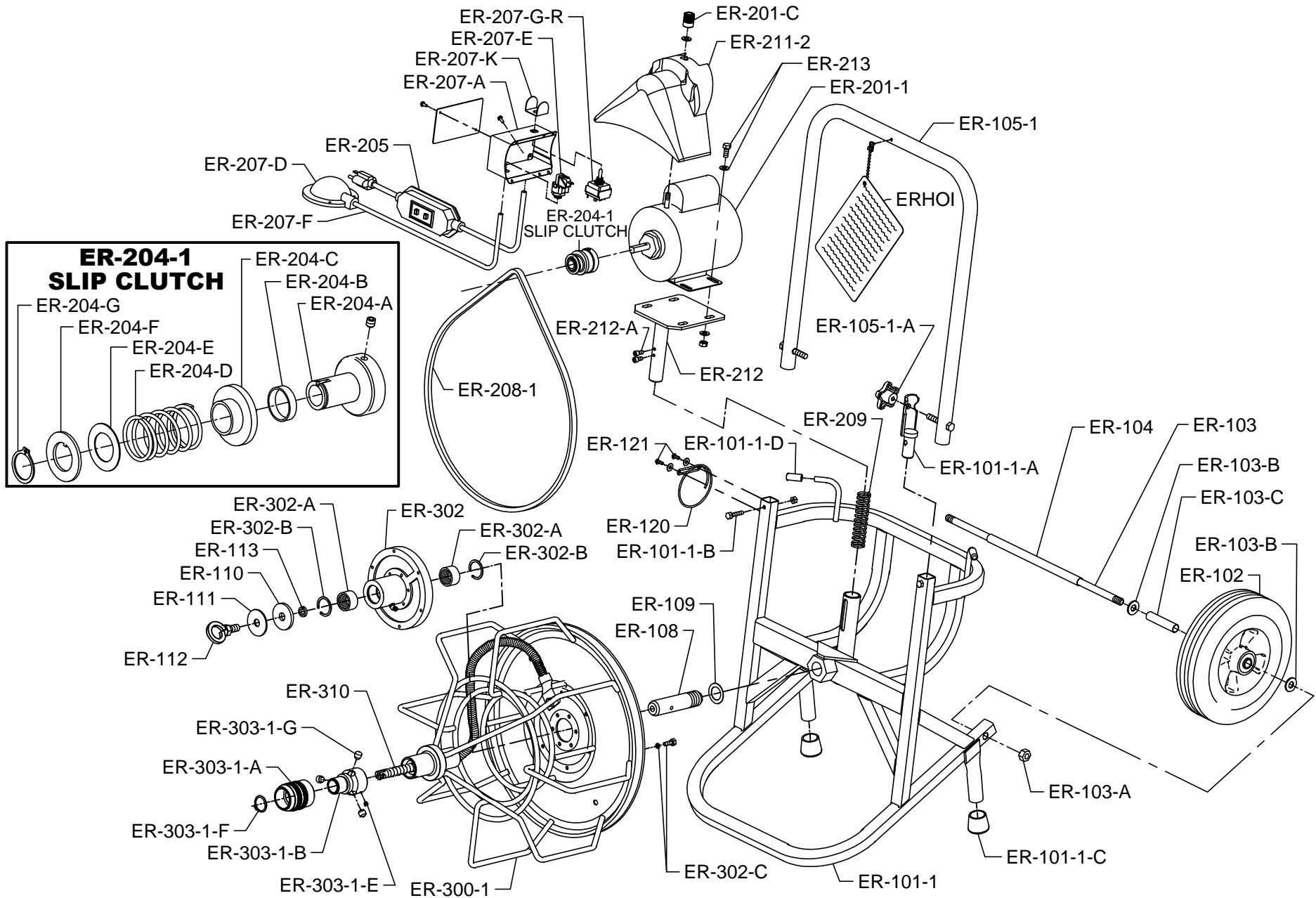

IMPORTANT: When ordering, give Serial Number of Machine.