

SPEEDROTER XL PARTS LIST

ITEM NO.	CATALOG NO.	DESCRIPTION	ITEM NO.	CATALOG NO.	DESCRIPTION
156015	SXL-100	Frame Complete	156290	SXL-480	Drum Shaft
156025	SXL-101	Fame Only w/Axle	156291	SXL-481	Wear Washer
156036	SXL-101-A	Handle Support Knob (2)	156295	SXL-482	Spacer Collar w/Set Screw
156045	SXL-101-C	Cord Wrap Cap	156297	SXL-490	Inner Drum Cage
156045	SXL-103	Stair Climber w/Belt (1)	154258	SXL-600-3/4	3/4 hp Motor w/Air Foot Switch, Rev. Switch, GFCI
156050	SXL-103-A	Nut, Bolt, & Washer (2)	156312	SXL-602	V-Belt Pulley
156055	SXL-103-B	Spacers (2)	156320	SXL-603	Belt Guard Knob
156061	SXL-107	Plated Handle Assembly	136000	GFI-20	20 ft. Power Cord w/GFCI
156066	SXL-107-A	Handle - Left	156330	S91-605	Air Foot Switch & Reverse Switch Assembly
156067	SXL-107-B	Handle - Right	154326	SXL-605-A	Box Only w/Cover & Screws
156075	SXL-107-C	6" Handle Wheel	136170	SXL-605-B	Foot Pedal & Hose
156080	SXL-107-D	Axle for Handle Wheel	154328	SXL-605-C	Cable Tie
156090	SXL-107-F	Felt Washer (2)	136080	SXL-605-E	Power Switch Diaphragm
156100	SXL-107-G	Bolt & Nut (2)	136130	SXL-605-G	Reverse Switch - 3-Way
156105	SXL-107-H	Set Screw (2)	170920	SXL-605-K	Switch guard
156125	SXL-109-A	Knob for Brake Rod	156395	S91-605-N	Strain Relief Nut
156135	SXL-110	10" Wheel w/Retaining Cap (1)	156345	SXL-609-3/4	Belt Guard (3/4 hp) w/Slot
156140	SXL-111	Wheel Retaining Cap (2)	156309	SXL-601	V-Belt (64")
156145	SXL-112	Wheel Spacer (2)	156020	SXL-7000	Power Cable Feed Assembly
170740	SXL-113	Weel Spacer Washer	156350	SXL-7101	Feed Body
156150	SXL-115	Axle	156355	SXL-7101-1	Feed Body for One Piece Feed Control Disk
156160	SXL-116	Motor Support Spring	156360	SXL-7101-A	Lifting Spring
156151	SXL-118	Motor Support Platform	156363	SXL-7101-B	Guide Pins (2)
170770	SXL-118-B	Guide Screws (2)	155012	SXL-7102	Mounting Stud
156168	SXL-118-C	Nuts (4), Bolts (4), & Washers (8)	156370	SXL-7103	Mounting Knob
156170	SXL-120	Front Bearing Assembly	155020	SXL-7104	Spout & Retaining Cover
156174	SXL-120-A	Front Bearing Knob	155021	SXL-7104-1	Spout for One Piece Feed Control Disk
156183	SXL-120-D	Mounting Bolts & Washers (2)	156380	SXL-7105	Steel Washer
156189	SXL-130	Rear Drum Shaft Clamp	155026	SXL-7200	Top Roller Assembly
156192	SXL-130-A	Drum Clamp Knob	155031	SXL-7210	Top Carrier Only
156201	SXL-130-D	Mounting Bolts & Washers (2)	155036	SXL-7220	Swing Pin
155999	SXL-400	Small Drum Complete w/Shaft & Distributor Tube (15")	155041	SXL-7225	Feed Roller Shaft
156210	SXL-402	Drum Shell	136120	SXL-7250	Feed Roller w/Bearing
156213	SXL-404	Drum Hub w/Bushings	155060	SXL-7301	Feed Pressure Knob
156215	SXL-404-A	Bushings (2)	155062	SXL-7301-A	Limiting Nut
153705	SXL-405	Nuts, Bolts, & Washers (5)	155066	SXL-7315	Pressure Spring
156216	SXL-407	Shaft Retaining Ring	155070	SXL-7330	Ball Bearing
156219	SXL-410	Drum Connecting Cable (for 1/2" Cables) w/ Nut & Screws	155076	SXL-7331	Ball Bearing Holder
156222	SXL-410-A	Connecting Cable Nut & Screws	155080	SXL-7340	Top Cover
156225	SXL-420	Small Drum Distributor Tube Assembly	155085	SXL-7341	Cover Screws (3)
156230	SXL-421	Distributor Tube Only	155091	SXL-7400	Bottom Roller Assembly
156231	SXL-422	Bushing	155096	SXL-7410	Bottom Carrier Only
156234	SXL-423	Retaining Ring	155100	SXL-7420	Swing Pin
156237	SXL-424	Thrust Bearing Race	155106	SXL-7425	Bottom Roller Shaft
156240	SXL-425	Distributor Tube Retaining Bolts and Lock Washers (2)	136120	SXL-7450	Bottom Roller w/Bearing
156245	SXL-430	Drum Shaft	155130	SXL-7530	Thrust Bearing
156247	SXL-431	Shaft Washer	155135	SXL-7540	Cable Adjustment Plate
156246	SXL-440	Inner Drum Cage	155140	SXL-7541	Plate Screws (3)
174520	SXL-440-A	Bushing	155145	SXL-7601	Feed Control Disk w/Lever & Knob
154390	SXL-614	Small Drum V-Belt (57")	155182	SXL-7601-A	Lever & Knob
156004	SXL-450	Large Drum Complete w/Shaft & Distributor Tube (18")	155150	SXL-7601-1	Feed Control Disk (One Piece)
156256	SXL-452	Drum Shell w/Bearings	155190	SXL-7635	Wave Washer
156258	SXL-454	Drum Hub Bearings (2)	155195	SXL-7635-1	Wave Washer for One Piece Feed Control Disk
156300	SXL-490-A	Bushing	156006	SXL-GT	Guide Tube
156261	SXL-460	Drum Connecting Cable (for 5/8" & 3/4" Cables) w/ Nut, Screws, & Lock Washer	136110	SXL-7703	Set of Feed Rollers (3)
156264	SXL-460-A	Nut, Screws, & Lock Washer	156008	SXL-TB	Tool Box
156267	SXL-470	Drum Distributor Tube Assembly	146160	GTE	Guide Tube Extension
156273	SXL-472	Bushing	132375	SXL-DECAL	Set of Safety Decals
156276	SXL-473	Retaining Ring	141170	SXL-DVD	Instructional DVD
156237	SXL-474	Thrust Bearing Race	130040	SRCS	Senior Cutter Set
156282	SXL-475	Distributor Tube Retaining Knob w/Bearing Assembly	130070	COCS	Combination Cutter Set
156285	SXL-475-A	Bearing Assembly for Retaining Knob	122080	100EM5	Flexicore Cable, 3/4" x 100 ft. w/ Male & Female Conn.
			122040	100EM4	Flexicore Cable, 5/8" x 100 ft. w/ Male & Female Conn.
			121090	100EM3	Flexicore Cable, 1/2" x 100 ft. w/ Male & Female Conn.

SPEEDROOTER XL SCHEMATIC DIAGRAM

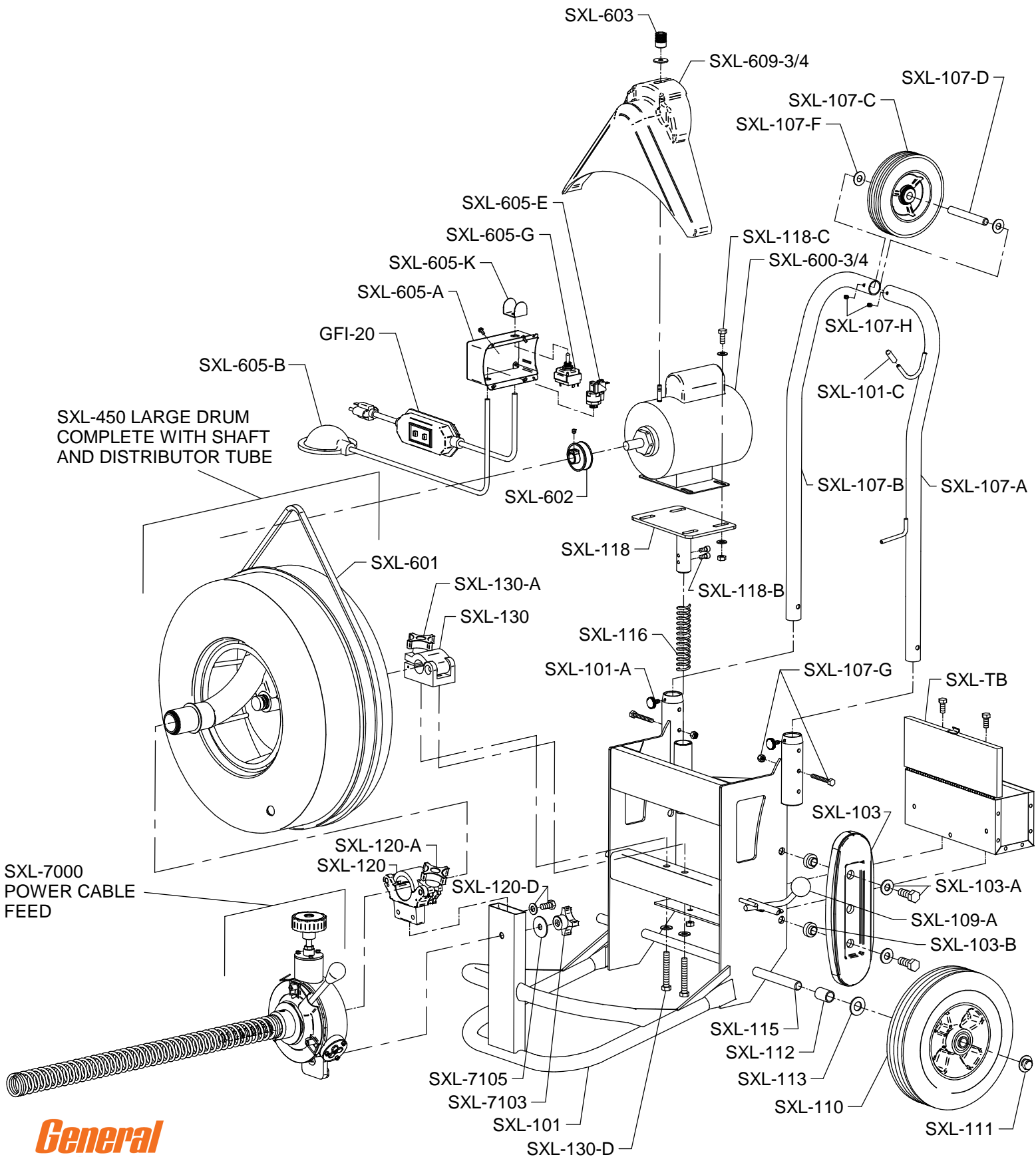

SPEEDROOTER XL SCHEMATIC DIAGRAM

