

THE METRO PARTS LIST

ITEM NO.	CATALOG NO.	DESCRIPTION	ITEM NO.	CATALOG NO.	DESCRIPTION
166450	ME-100-1	Complete Frame w/ 5/8" Axle	166635	ME-602	V-Belt Pulley (1-1/2" for 9/16" Cable)
166454	ME-100-2	Complete Frame w/ 5/8" Axle for Stair Climbers	166637	ME-602-2	V-Belt Pulley (2" for 5/8" & 3/4" Cables)
166453	ME-100-1-R	Complete Frame w/ 5/8" Axle	136180	ME-602-R	Slip Clutch
166455	ME-101-1	Frame Only w/ 5/8" Axle	166640	ME-603	Motor Support Bolts, Nuts, Washers
166458	ME-101-2	Frame Only w/ 5/8" Axle for Stair Climbers	136000	GFI-20	20' Power Cord w/GFCI
166457	ME-101-1-R	Frame Only w/ 5/8" Axle	166650	ME-610	Foot Switch & Reverse Switch Assembly
166460	ME-101-A	Rubber Leg Tips (2)	166653	ME-610-R	Foot Switch & Reverse Switch Assembly (Red Switch)
166465	ME-101-B	Rubber Cord Wrap Tips	166655	ME-610-A	Box Only w/Cover & Screws
166470	ME-101-C	Cutter Holder w/Screws (2) & Washers (2)	136170	ME-610-B	Foot Pedal & Hose
171202	ME-101-D	Cutter Holder Screws & Washers (2)	166665	ME-610-C	Hose Clamp
166475	ME-102	Distributor Tube Clamp	136060	ME-610-D	Pedal Only
166480	ME-102-A	Clamp Locking Knob	136080	ME-610-E	Power Switch Diaphragm
166485	ME-102-B	Clamp Screws & Washers (2)	136050	ME-610-F	Air Hose
166476	ME-103	Stair Climber	136130	ME-610-G	Reverse Switch (3-Way)
166477	ME-103-A	Bolts, Nuts, Flat Washers, & Lock Washers (2)	136210	ME-610-G-R	Momentary Contact Reverse Switch (Red)
166478	ME-103-B	Plastic Spacers (2)	166693	ME-610-K	Switch Guard
166487	ME-104	Guide Tube Holder	166695	ME-610-N	Strain Relief Nut
166490	ME-105	Hinge	166700	ME-615	Belt Guard
166495	ME-105-A	Hinge Bolts & Nuts (2)	166705	ME-616	Knob for Belt Guard
166500	ME-106	Handle Locking Knobs (2)	166701	ME-617	Belt Guard Washer
166505	ME-107	Handles	166420	ME-7000	Power Feed Cable Assembly
166507	ME-107-R	Handles	166423	ME-7000-R	Power Feed Cable Assembly
166510	ME-107-A	Left Handle	156355	ME-7101-1	Feed Body for One Piece Feed Control Disk
166513	ME-107-A-R	Left Handle	156360	ME-7101-A	Lifting Spring
166515	ME-107-B	Right Handle	156363	ME-7101-B	Guide Pins (2)
166517	ME-107-B-R	Right Handle	155012	ME-7102	Mounting Stud
166520	ME-107-C	Handle Wheel	156370	ME-7103	Mounting Knob
166525	ME-107-D	Handle Wheel Axle	155021	ME-7104-1	Spout for One Piece Feed Control Disk
166530	ME-107-E	Felt Washers (2)	156380	ME-7105	Steel Washer
166535	ME-107-F	Set Screws (2)	155026	ME-7200	Top Roller Assembly
166536	ME-107-G	Bushings (2)	155025	ME-7200-R	Top Roller Assembly
166537	ME-110-1	10" Mag Wheel w/Cap	155031	ME-7210	Top Carrier Only
166543	ME-111-1	10" Mag Wheel Retainer Cap (2)	155036	ME-7220	Top Swing Pin
166553	ME-112-1	10" Mag Wheel Spacer (2)	155105	ME-7220-R	Top Swing Pin
166555	ME-115	Drum Shaft	155041	ME-7225	Feed Roller Shaft
166560	ME-116	Thrust Bearing	136120	ME-7250	Feed Roller w/Bearing
166565	ME-120	Motor Support w/Bolts, Nuts, & Washers	155060	ME-7301	Feed Pressure Knob
166570	ME-120-A	Guide Screws (2)	155062	ME-7301-A	Limiting Nut
166575	ME-125	Motor Support Spring	155066	ME-7315	Pressure Spring
166580	ME-200	Flexitube Distributor Tube Assembly	155070	ME-7330	Ball Bearing
166410	ME-400	Drum Complete	155076	ME-7331	Ball Bearing Holder
166413	ME-400-R	Open Drum Complete	155080	ME-7340	Top Cover Plate
166585	ME-402	Drum Shell	155085	ME-7341	Plate Screws (3)
166587	ME-402-R	Open Drum Shell	155091	ME-7400	Bottom Roller Assembly
166590	ME-405	Drum Bearings (2)	155092	ME-7400-R	Bottom Roller Assembly
166595	ME-408	Drum Bushing	155096	ME-7410	Bottom Carrier Only
166600	ME-409	Inner Drum Cage	155100	ME-7420	Swing Pin
166603	ME-409-R	Inner Drum Cage	155105	ME-7420-R	Swing Pin
166605	ME-410	Drum Connecting Cable w/ Nut, Screws, & Lock Washer	155106	ME-7425	Bottom Roller Shaft
166610	ME-410-A	Connecting Cable Nut, Screws, & Lock Washer	136120	ME-7450	Bottom Feed Roller w/Bearing
166604	ME-410-R	Drum Connecting Cable w/ Nut, Screw, & Lock Washer	155130	ME-7530	Thrust Bearing
166611	ME-410-A-R	Connecting Cable Nut, Screw, & Lock Washer	155135	ME-7540	Cable Adjustment Plate
166615	ME-425	Drum Retaining Bolt w/Grease Fitting	155140	ME-7541	Plate Screws (3)
166620	ME-426	Retaining Washer	155150	ME-7601-1	Feed Control Disk (One Piece)
166625	ME-427	Felt Washer	155195	ME-7635-1	Wave Washer for One Piece Feed Control Disk
166624	ME-428	High Collar Lock Washer	136110	PO-703	Set of Feed Roller Assemblies (3)
166440	ME-600	1/3 hp Capacitor Motor w/Foot Switch, Reverse Switch, & GFCI	166430	ME-GT	Guide Tube for Metro Rooter
166445	ME-600-R	1/3 hp Capacitor Motor w/Foot Switch, Momentary Contact Reverse Switch, & GFCI	146160	GTE	Guide Tube Extension
166630	ME-601	V-Belt (55" for 1-1/2" Pulley)	132210	ME-DECAL	Set of Safety Decals
166633	ME-601-2	V-Belt (56" for 2" Pulley)	166710	ME-SCA	Stair Climber Assembly
136190	ME-601-R	V-Belt (52")	170990	AFH	Condensed Operating Instructions (Instructions w/Chain & Fittings, Connector, & Screw)
			166720	MEOI	Complete Operating Instructions

* "-R" Indicates for rental machine only

THE METRO SCHEMATIC DIAGRAM

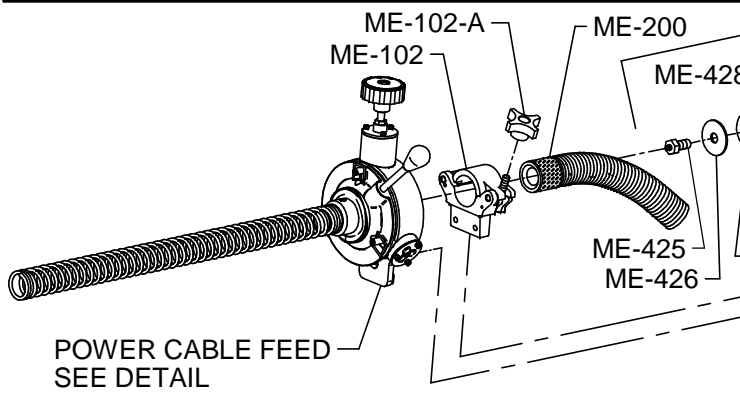
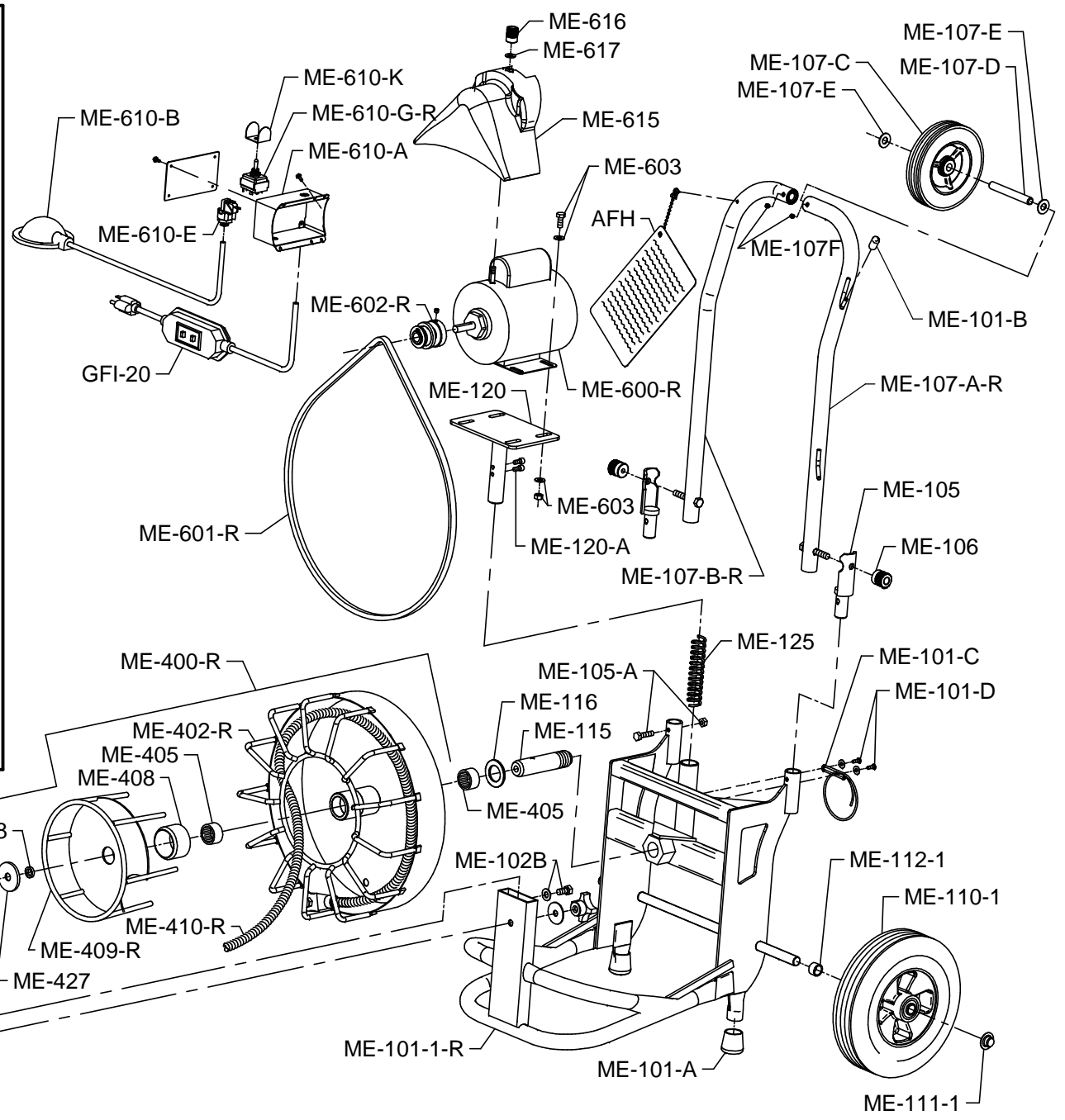
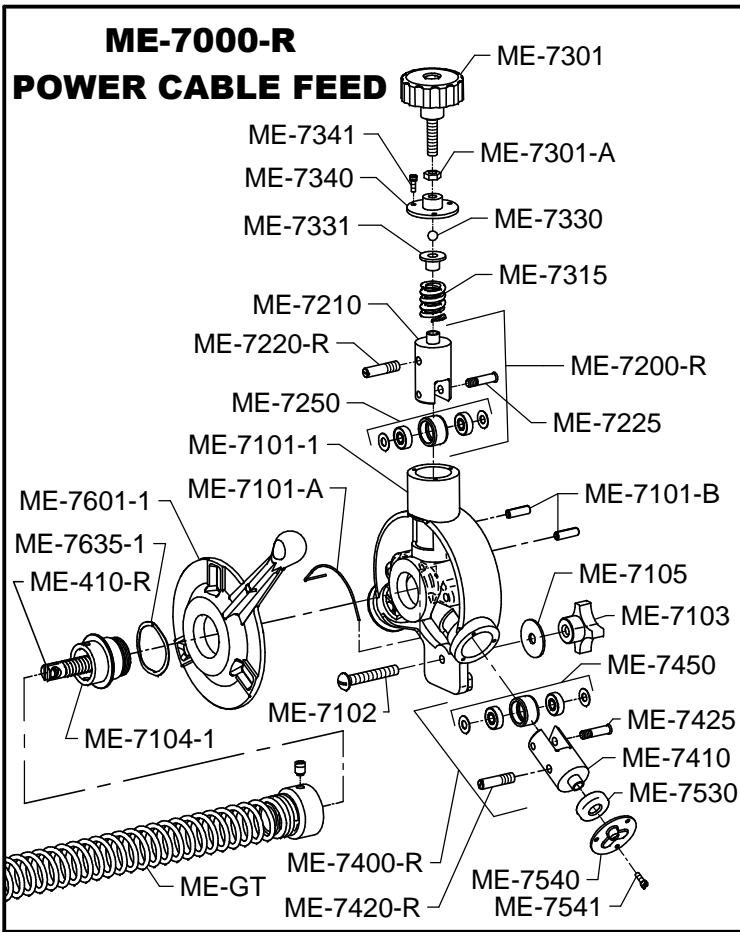

IMPORTANT: When ordering, give Serial Number of Machine.