

Easy Rooter Junior[™] *Operating Instructions*

For 2" through 4" lines
(50mm—100mm)



Your Easy Rooter Junior is designed to give you years of trouble-free, profitable service. However, no machine is better than its operator.

Read, understand and follow all safety warnings and instructions provided with the product. Failure to follow the warnings and instructions may result in electric shock and/or serious injury. Save all warnings and instructions for future reference.

SAVE THESE INSTRUCTIONS!

General
PIPE CLEANERS



! WARNING

Read and understand operator's manual before using this machine. Failure to follow operating instructions could result in death or serious injury.

WARNING! Read and understand all instructions. Failure to follow all instructions listed below may result in electric shock, fire and/or serious personal injury. Replacement manuals are available upon request at no charge, or may be downloaded from our website, www.drainbrain.com. Instructional videos are available for download on our website, and may be ordered. If you have any questions or problems, please call General's customer service department at 412-771-6300.

SAVE THESE INSTRUCTIONS!

These instructions are intended to familiarize all personnel with the safe operation and maintenance procedures for the Easy Rooter Junior.

SAFETY SYMBOLS



This is the safety alert symbol. It is used to alert you to potential personal injury hazards. Obey all safety messages that follow this symbol to avoid possible injury or death.

! DANGER

DANGER indicates a hazard with a high level of risk which, if not avoided, will result in death or serious injury.

! WARNING

WARNING indicates a hazard with a medium level of risk which, if not avoided, could result in death or serious injury.

! CAUTION

CAUTION indicates a hazard with a low level of risk which, if not avoided, will result in minor or moderate injury.

! WARNING



Electric shock resulting in death can occur if you plug this machine into an improperly wired outlet. If the ground wire is electrified, you can be electrocuted by just touching the machine, even when the power switch is off. A ground fault circuit interrupter will not protect you in this situation. Use a UL approved tester to determine if the outlet is safe.

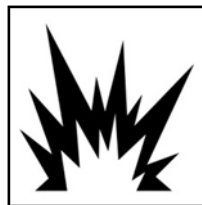

Do not operate power tools in explosive atmospheres, such as in the presence of flammable liquids, gases, or dust. Power tools create sparks which may ignite the dust or fumes.



Only wear leather gloves. Never use any other type of glove, such as cloth, rubber, or coated gloves. Never grasp a rotating cable with a rag. These items could become wrapped around the cable and cause serious injury.



Always wear safety glasses and rubber soled, non-slip shoes. Use of this safety equipment may prevent serious injury.



Never operate machine with belt guard removed. Fingers can get caught between belt and pulley.



Do not overstress cables. Overstressing cables may cause twisting, kinking, or breaking of the cable and may result in serious injury.

GENERAL SAFETY RULES



WARNING

Read and understand all instructions. Failure to follow all instructions listed below may result in electric shock, fire, and/or serious injury.

SAVE THESE INSTRUCTIONS!

Work Area

1. **Keep work area clean and well lit.** Cluttered benches and dark areas invite accidents.
2. **Do not operate power tools in explosive atmospheres, such as in the presence of flammable liquids, gases, or dust.** Power tools create sparks which may ignite the dust or fumes.
3. **Keep bystanders, children, and visitors away while operating a power tool.** Distractions can cause you to lose control.

Electrical Safety

1. **Grounded tools must be plugged into an outlet, properly installed and grounded in accordance with all codes and ordinances. Never remove the grounding prong or modify the plug in any way. Do not use any adapter plugs. Check with a qualified electrician if you are in doubt as to whether the outlet is properly grounded.** If the tool should electrically malfunction or break down, grounding provides a low resistance path to carry electricity away from the user.
2. **Avoid body contact with grounded surfaces such as pipes, radiators, ranges and refrigerators.** There is an increased risk of electric shock if your body is grounded.
3. **Do not expose power tools to rain or wet conditions.** Water entering a power tool will increase the risk of electric shock.
4. **Do not abuse the cord.** Never use the cord to carry the tools or pull the plug from an outlet. Keep cord away from heat, oil, sharp edges or moving parts. Replace damaged cords immediately. Damaged cords increase the risk of electric shock.
5. **When operating a power tool outside use an outdoor extension cord marked “W-A” or “W”.** These cords are rated for outdoor use and reduce the risk of electric shock.
6. **Test the Ground Fault Circuit Interrupter (GFCI) provided with the power cord to insure it is operating correctly before operating machine.** Machine must have a properly functioning ground fault circuit interrupter on the power cord. GFCI reduces the risk of electric shock.
7. **Extension cords are not recommended unless they are plugged into a Ground Fault Circuit Interrupter (GFCI) found in circuit boxes or outlet receptacles.** The GFCI on the machine power cord will not prevent electric shock from the extension cords.
8. **Only use proper three-wire extension cords in good condition which have three-prong grounding plugs and three-pole receptacles which accept the tool’s plug.** Use of damaged, inferior, or other extension cords will not ground the tool. Increases the risk of electric shock and bodily injury or death.
9. **Keep all electric connections dry and off the ground.** Reduces the risk of electric shock.
10. **DO NOT touch plugs or tools with wet hands.** Reduces the risk of electric shock.

Personal Safety

1. **Stay alert, watch what you are doing and use common sense when operating a power tool. Do not use tool while tired or under the influence of drugs, alcohol, or medication.** A moment of inattention while operating power tools may result in serious personal injury.
2. **Dress properly. Do not wear loose clothing or jewelry. Contain long hair. Keep your hair, clothing, and gloves away from moving parts.** Loose clothes, jewelry, or long hair can be caught in moving parts.
3. **Avoid accidental starting. Be sure switch is off before plugging in.** Carrying tools with your finger on the switch or plugging in tools that have the switch on invites accidents.
4. **Remove adjusting keys or wrenches before turning the tool on.** A wrench or key that is left attached to a rotating part of the tool may result in personal injury.
5. **Do not overreach. Keep proper footing and balance at all times.** Proper footing and balance enables better control of the tool in unexpected situations.
6. **Use safety equipment. Always wear eye protection.** Dust mask, non-skid safety shoes, hard hat, or hearing protection must be used for appropriate conditions.

Tool Use and Care

1. **Use clamps or other practical way to secure and support the workpiece to a stable platform.** Holding the work by hand or against your body is unstable and may lead to loss of control.
2. **Do not force tool. Use the correct tool for your application.** The correct tool will do the job better and safer at the rate for which it is designed.
3. **Do not use tool if switch does not turn it on or off.** Any tool that cannot be controlled with the switch is dangerous and must be repaired.
4. **Disconnect the plug from the power source before making any adjustments, changing accessories, or storing the tool.** Such preventative safety measures reduce the risk of starting the tool accidentally.
5. **Store idle tools out of reach of children and other untrained persons.** Tools are dangerous in the hands of untrained users.
6. **Maintain tools with care. Keep cutting tools sharp and clean.** Properly maintained tools, with sharp cutting edges are less likely to bind and are easier to control.
7. **Check for misalignment or binding of moving parts, breakage of parts, and any other condition that may affect the tool’s operation. If damaged, have the tool serviced before using.** Many accidents are caused by poorly maintained tools.
8. **Only use accessories that are recommended by the manufacturer for your model.** Accessories that may be suitable for one tool may become hazardous when used on another tool.

Service

1. **Tool service must be performed only by qualified repair personnel.** Service or maintenance performed by unqualified repair personnel could result in a risk of injury.
2. **When servicing a tool, use only identical replacement parts. Follow instructions in the Maintenance section of this manual.** Use of unauthorized parts or failure to follow Maintenance Instructions may create a risk of electric shock or injury.

SPECIFIC SAFETY RULES



This is the safety alert symbol. It is used to alert you to potential personal injury hazards. Obey all safety messages that follow this symbol to avoid possible injury or death.



Electric shock resulting in death can occur if you plug this machine into an improperly wired outlet. If the ground wire is electrified, you can be electrocuted by just touching the machine, even when the power switch is off. A ground fault circuit interrupter will not protect you in this situation. Use a UL approved tester to determine if the outlet is safe.



Do not overstress cables. Overstressing cables may cause twisting, kinking, or breaking of the cable and may result in serious injury.

1. **Only wear leather gloves.** Never use any other type of glove, such as cloth, rubber, or coated gloves. Never grasp a rotating cable with a rag. These items could become wrapped around the cable and cause serious injury.
2. **Never operate machine with belt guard removed.** Fingers can get caught between belt and pulley.
3. **Do not overstress cables.** Keep leather-gloved hand on the cable for control when machine is running. Overstressing cables because of an obstruction may cause twisting, kinking, or breaking of the cable and may result in serious injury.
4. **Place the machine at a distance not greater than two feet from the opening.** Greater distances can result in cable twisting or kinking.
5. **Machine is designed for ONE-PERSON operation.** Operator must control foot switch and cable.
6. **Do not operate machine in reverse (REV).** Operating machine in reverse can result in cable damage and is used only to back cutting tool out of an obstruction.
7. **Keep hands away from rotating drum.** Do not reach into drum unless machine is unplugged. Hand may be caught in the moving parts resulting in serious injury.
8. **Be careful when cleaning drains where cleaning chemicals have been used.** Avoid direct contact with skin and eyes. Drain cleaning chemicals can cause serious burns as well as damage the cable.
9. **Do not operate machine if operator or machine is standing in water.** Will increase risk of electrical shock.
10. **Wear safety glasses and rubber soled, non-slip shoes.** Use of this safety equipment may prevent serious injury.
11. **Before starting each job, check that the cable in the drum is not broken or kinked, by pulling the cable out and checking for wear or breakage.** Always replace worn out (kinked or broken) cables with genuine GENERAL replacement cables.
12. **Only use this tool in the application for which it was designed. Follow the instructions on the proper use of the machine.** Other uses or modifying the drain cleaner for other applications may increase risk of injury.
13. **The motor is equipped with a thermal overload protector to guard against overheating.** If the motor shuts off due to overheating, wait for the motor to cool sufficiently, then press the reset button located in the back of the motor.

Ground Fault Circuit Interrupter (GFCI)

Your machine is equipped with a ground fault circuit interrupter, which protects you against shock if a short circuit should occur. Check that receptacle is properly grounded. Test the GFCI before each use.

1. Plug into 120-volt receptacle.
2. Push test button. Indicator light will go out and power to machine should cut off.
3. If light does not go out when test button is pushed, **DO NOT USE THE MACHINE** until proper repairs can be made.
4. To restore power after test, push reset button. With the reset button depressed, if the machine doesn't start, stops while running, or if the operator experiences a mild shock, **DO NOT USE THE MACHINE!** Tag the machine out of service and take it to a motor repair center or return it to the factory for repairs.



THE SECTION OF CORD BETWEEN THE WALL PLUG AND THE GFCI IS NOT IN THE PROTECTED CIRCUIT.

FEATURES

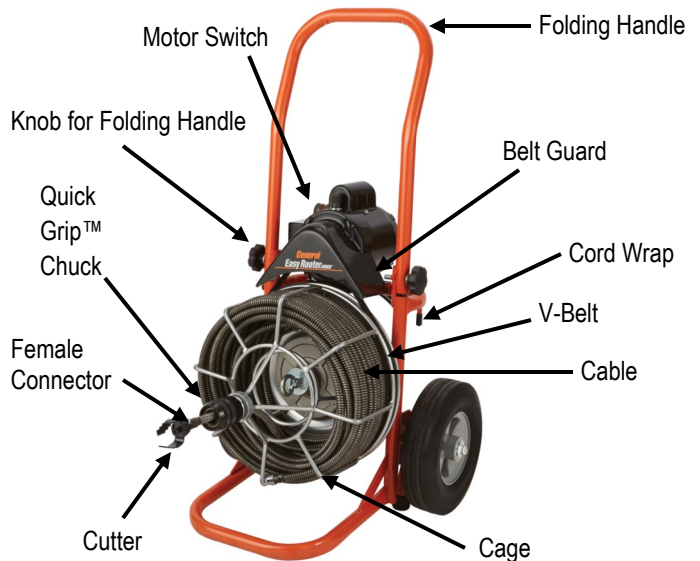





NOTE: Do not operate machine if warning labels on the switch box and power cord are missing or illegible.

Cable Application Chart (Table 1)

Cable Size	Pipe Size	Typical Applications
1/2"	2" to 4"	Laundry Tubs, Roof Vents, Stacks (No Roots)

Cutter Application Chart (Table 2)

Cutter	Cat. #	Typical Applications
Arrow Head 	AH	Starting tool, ideal for cutting and scraping.
1-1/2" U-Cutter 	1-1/2UC	Starting tool, to remove loose objects.
2" U-Cutter 	2UC	Finishing tool, for scraping inside edges of pipe.
Small Retrieving Tool 	RTR-1	To remove loose objects.

Note: There are no fixed rules about which cutter to use. If one tool doesn't take care of a stoppage, simply try another.

Operating Instructions
Set-Up

 **MAKE SURE THE MOTOR SWITCH IS IN THE 'OFF' POSITION!**

1. Be sure the motor switch is in the **off** position.
2. Place machine at a distance not greater than two feet (.6m) from the drain opening. If you cannot get the machine this close to the opening, run the cable through a hose or pipe to prevent cable whipping. Always keep a leather-gloved hand on the cable.
3. Position the foot pedal for easy accessibility. The machine is designed for one-person operation. Be sure you can quickly remove your foot from the pedal in an emergency.
4. Select the proper cutting tool (See Cutter Application Chart—Table 2). A good tool to start with is the Arrow Head or 1-1/2" U-Cutter. After the line is opened, follow with larger blades, which scrape the inside edges of the pipe, assuring a real cleaning job.
5. Insert the cutter into the female connector at the end of the 1/2" cable and tighten the connecting screw and lock washer *firmly* in place.



Operation

1. Loosen the chuck at the front of the cage and pull the cable out of the cage, then put it into the drain until it will not go any farther. Pull another foot of cable out of the cage so that an arc is formed between the machine and drain. Tighten the chuck on the front of the cage firmly against the cable.
2. Put the motor switch in the **Forward** position. Then, with both leather-gloved hands on the cable, step on the foot pedal. Guide the cable into the line with a firm, even pressure.

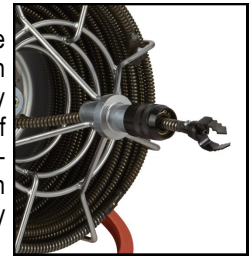

DO NOT USE TOO MUCH FORCE – LET THE CUTTER DO THE WORK.

3. Do not leave too much slack in the cable since this will cause whipping. If the cable starts to bend or build up too much twist, release pressure on the foot pedal and rotate the cage in the opposite direction to relieve the twist on the cable. Push any excess cable back into the cage and then continue.

 **DO NOT ALLOW TOO MUCH SLACK IN THE CABLE BETWEEN MACHINE AND DRAIN OPENING SINCE THIS CAN CAUSE CABLE WHIPPING.**

4. When the slack cable has been fed into the drain, stop the machine by taking your foot off the pedal. Loosen the chuck and pull another foot of cable from the cage. Tighten the chuck and continue feeding. Repeat the procedure until the drain line has been cleared.
5. If you are having trouble getting around bends, try putting the machine in reverse while applying steady pressure. Note: If your machine is equipped with a momentary contact reverse switch, you must hold the switch in position when operating the machine in reverse.

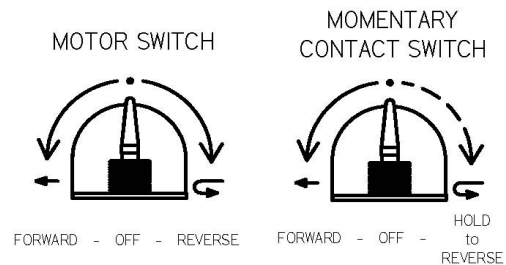

Do not run motor in reverse for more than a few seconds at a time since this could cause tangling in the cage or kinking.

6. If you still cannot get around the bend, you are probably using too large of a cable. You may need to switch to a smaller machine (See Cable Application Chart).
7. After the line is opened, return the cable to the cage with the motor turning **Forward**. This is important to prevent tangling the cable in the cage or in the line.

 **DO NOT USE REVERSE TO PULL THE CABLE OUT OF THE DRAIN. RUNNING MACHINE IN REVERSE CAN CAUSE THE CABLE TO TANGLE IN THE CAGE.**

- When the cutter is near the drain opening, take your foot off the pedal to stop drum rotation. Never retract the cutting tool from drain while cable is rotating. The cable could whip and cause serious injury.

Hint: It's often helpful to have a small stream of water running in the line to wash the cuttings away while the machine is in operation and after.

Special Operations

IF CABLE GETS CAUGHT IN LINE

The motor can be reversed to free cable if it gets caught in the line. Use the following procedure:

- Tighten chuck at front of cage firmly against cable.
- Move toggle switch on motor to reverse position.
- Wearing leather gloves, pull on cable while the cage is turning in reverse.



DO NOT RUN MOTOR IN REVERSE FOR MORE THAN A FEW SECONDS AT A TIME SINCE THIS COULD CAUSE THE CABLE TO KINK OR TANGLE IN THE CAGE.

- When the cable has been freed, loosen chuck and slide excess cable back into cage.
- Move the toggle switch to the forward position again, and continue at Step 3 of the Operating Instructions.

IF CABLE TANGLES IN CAGE

This is almost always caused by using too much pressure when feeding the cable or by feeding the cable while running the machine in reverse. To untangle, rotate cage in opposite direction. If cable has become badly tangled, which will not happen when machine is used properly, it may be necessary to pull the entire cable out of the cage and re-install it (See "How to Install Cable").

HOW TO INSTALL CABLE IN CAGE



DISCONNECT MACHINE FROM POWER SOURCE BEFORE INSTALLING CABLES OR CAGES!

- Connect male end of cable to the cage connecting cable already attached to cage.
- Remove V-Belt.
- Turn cage with one hand while pushing cable into cage with other hand.
- Be sure cable goes into cage as shown in the illustration, or cable will tangle in cage.
- Replace V-Belt after cable is installed.

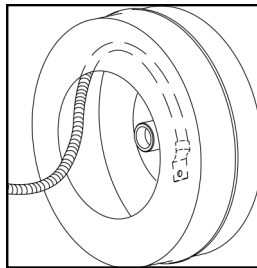

NOTE: The cable must lay in the cage in the correct direction or it will tangle in the cage.



HOW TO EXCHANGE CAGES

- Unscrew ring bolt in center of cage.
- Lift belt guard off motor.
- Push motor down far enough to slip V-Belt off.
- Tilt Easy Rooter Junior on its back and lift cage off of shaft.
- Reverse procedure to install cage.

MAINTENANCE



DISCONNECT MACHINE FROM POWER SOURCE BEFORE PERFORMING MAINTENANCE!

To keep your machine operating smoothly, it is essential that all bearings and distributor tube bushings be lubricated. Oiling moving parts is particularly important where machine comes in contact with sand, grit and other abrasive material.

CABLE MAINTENANCE

To get maximum service from your cables, be sure that they are clean and well oiled. This not only provides running lubrication but greatly extends the life of the cables as well. Some users periodically pour oil directly into the cage. Then, as the cage turns, the cables get complete lubrication. Our SNAKE OIL is ideally suited for this purpose, since it not only lubricates the cables, it deodorizes them as well.



TANGLED CABLE: If a cable loops over itself in the cage, it will not feed properly. Remove and reload the cable to restore function. If the cable kinks, it is evidence of abuse and results from the use of too much pressure or use of the wrong size cable for the line. Do not force the cable — let the cutter do the work.

QUICK GRIP™ CHUCK MAINTENANCE

Keep chuck free of excessive soil and grit. It is recommended that the chuck be lubricated regularly. The chuck can be lubricated without removing the retaining ring by loosening the chuck knob to expose as much of the grippers as possible. If the chuck no longer properly grips the cable, the grippers may have to be replaced. To most effectively lubricate the chuck or to replace the grippers, follow the steps below.

- Remove the retaining ring at the end of the chuck.
- Remove chuck knob and remove grippers.
- Clean parts thoroughly.
- Lubricate areas illustrated below. (Marine grease is recommended.)
- If necessary, replace all three grippers.
- Install chuck knob.
- Install retaining ring.

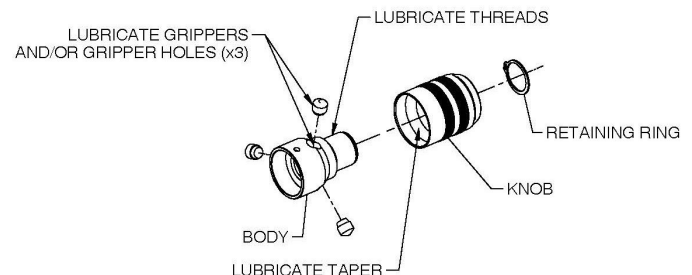

TROUBLE SHOOTING GUIDE (TABLE 3)

Problem	Probable Cause	Solution
Cable kinking, tangling or breaking.	Cable is being forced.	Do not force the cable! Let the cutter do the work.
	Cable used in incorrect pipe diameter.	Use 1/2" cables in 2" to 4" lines (Do not use 1/2" cables on roots).
	Motor switched to reverse.	Use reverse only if cable gets caught in pipe – only for a few seconds at a time.
	Cable exposed to acid.	Clean and oil cables regularly.
	Cable worn out.	Cable can be repaired using "Quick Fix" or "Repair Sleeve." If cable has broken several times, replace it.
Cable tangles in cage.	Operator forcing cable.	Do not force the cable. Let the cutter do the work.
	Machine running in reverse.	Do not run the machine in reverse to retract the cable from the drain.
Cage stops while foot pedal depressed.	Hole in pedal or hose.	Replace damaged component.
	Hole in diaphragm switch.	If no problem found with pedal or hose, replace diaphragm switch.
	Thermal overload activated.	Allow motor to cool. Press reset switch.
Cage turns in one direction but not other.	Faulty reverse switch or momentary contact switch.	Replace switch. Note: Momentary contact switch must be held in position when using reverse.
Ground Fault Circuit Interrupter trips when machine is plugged in or when foot pedal is depressed.	Frayed power cord.	Replace cord set.
	Short circuit in motor.	Take motor to authorized service center (Call General for Details).
	Excess moisture in area.	Remove excess moisture from area.
	Faulty Ground Fault Circuit Interrupter.	Replace Ground Fault Circuit Interrupter.
Motor turns but cage does not.	Slip clutch slipping because cable is being forced.	Do not force cable. Do not allow too much slack between cable and machine.
	Slip clutch is worn.	Replace slip clutch.

**EASY ROOTER JUNIOR
SCHEMATIC DIAGRAM**

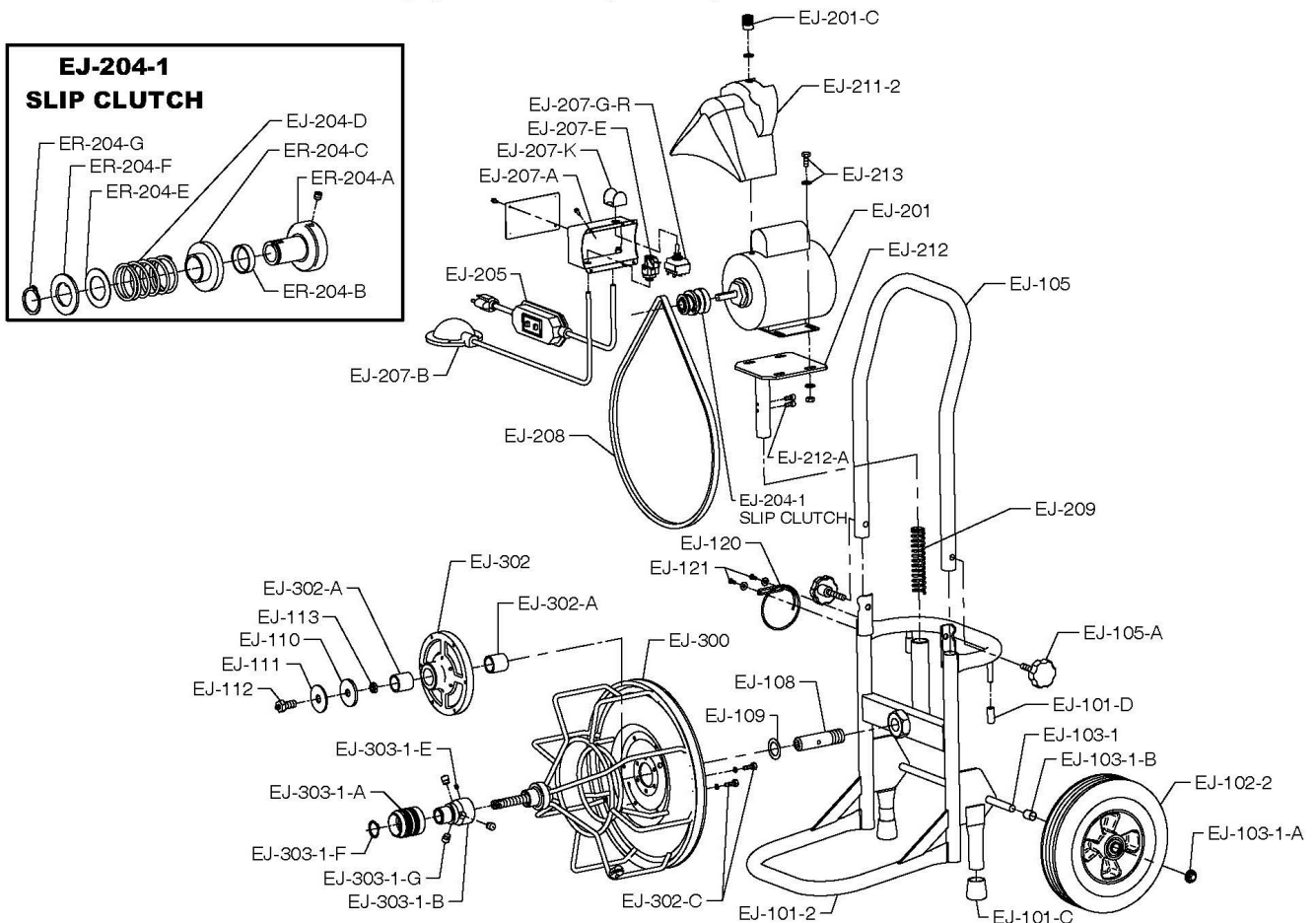

IMPORTANT: When ordering, give Serial Number of Machine.

EASY ROOTER JUNIOR PARTS LIST

CAT. NO.	DESCRIPTION	CAT. NO.	DESCRIPTION
EJ-100-2	Complete Frame w/Heavy Duty Wheel	EJ-204-1	Slip Clutch
EJ-101-2	Frame Only (Heavy Duty Wheel)	ER-204-A	Fixed Pulley Half
EJ-101-C	Passive Brakes (Rubber Leg Tip (2))	ER-204-B	Spacer
EJ-101-D	Cord Wrap Cap (2)	ER-204-C	Moveable Pulley Half
EJ-102	8" Rubber Wheel (1)	EJ-204-D	Spring
EJ-102-1	10" Rubber Wheel (1)	ER-204-E	Thrust Washer
EJ-102-2	10" Rubber Wheel (1) (Heavy Duty Wheel)	ER-204-F	Thrust Bearing
EJ-103	Axle (10" Wheel)	ER-204-G	Retaining Ring
EJ-103-A	Wheel Caps (2)	EJ-205	20' Power Cord w/Plug & GFCI
EJ-103-B	Axle Washers (2)	EJ-207	Air Foot Switch and Rev. Switch Assembly
EJ-103-1	5/8" Axle (Heavy Duty Wheel)	EJ-207-A	Box Only with Cover & Screws
EJ-103-1-A	Wheel Caps for 5/8" Axle (2)	EJ-207-B	Foot Pedal & Hose
EJ-103-1-B	Axle Spacers (2)	EJ-207-C	Hose Clamp (2)
EJ-105	Handle with Knobs	EJ-207-D	Foot Pedal
EJ-105-A	Handle Locking Knob (2)	EJ-207-E	Power Switch Diaphragm
EJ-106	Brake Rod	EJ-207-F	Air Hose
EJ-106-A	Roll Pin (1/8" x 1")	EJ-207-G-R	Momentary Contact Reverse Switch Only (Red)
EJ-107	Brake Rod Handle w/Knob	EJ-207-H	Rubber Switch Boot
EJ-107-A	Plastic Knob	EJ-207-K	Switch Guard
EJ-107-B	Axle Retaining Pin (1/8" x 5/8")	EJ-208	V-Belt (47")
EJ-107-C	Brake Rod Latch w/Screws	EJ-209	Motor Support Spring
EJ-108	Drum Support Shaft	EJ-211	Belt Guard w/Velcro
EJ-109	Bronze Thrust Washer	EJ-211-2	Belt Guard w/Slot for Stud
EJ-110	Felt Washer	EJ-212	Motor Support Bracket with Guide Screws
EJ-111	Drum Hub Retaining Washer	EJ-212-A	Guide Screws (2)
EJ-112	Drum Shaft Retaining Bolt	EJ-213	Nuts, Bolts, Washers (4)
EJ-113	High Collar Lock Washer	EJ-300	Cage with Hub and Bearings
EJ-116	Screws & Washers (2)	EJ-302	Cage Hub with Bearings
EJ-120	Tool Holder	EJ-302-A	Cage Hub Bearings (set)
EJ-121	Tool Holder Screws & Washers (2)	EJ-302-C	Bolts & Lock Washers (12)
EJ-201	1/3 hp Capacitor Motor Complete w/Air Foot Switch, Rev. Switch Assembly, & GFCI	EJ-303	Cable Locking Thumb Screw
EJ-201-C	Knob	EJ-303-1	Quick-Grip Chuck Assembly
		EJ-303-1-A	Grip Knob
		EJ-303-1-B	Quick-Grip Body
		EJ-303-1-E	Set Screw
		EJ-303-1-F	Retaining Ring
		EJ-303-1-G	Set of Grippers (3)
		EJ-DECAL	Set of Safety Decals
		EJ-VIDEO	Instructional DVD

General Wire Spring Co.
1101 Thompson Avenue
McKees Rocks, PA 15136
412-771-6300 www.drainbrain.com