

# *The Metro<sup>®</sup>* *Operating Instructions*

For 3" through 10" lines  
(75mm—250mm)



Your Metro is designed to give you years of trouble-free, profitable service. However, no machine is better than its operator.

Read, understand and follow all safety warnings and instructions provided with the product. Failure to follow the warnings and instructions may result in electric shock and/or serious injury. Save all warnings and instructions for future reference.

**SAVE THESE INSTRUCTIONS!**

***General***  
***PIPE CLEANERS***



**WARNING**

Read and understand operator's manual before using this machine. Failure to follow operating instructions could result in death or serious injury.

**WARNING!** Read and understand all instructions. Failure to follow all instructions listed below may result in electric shock, fire and/or serious personal injury. Replacement manuals are available upon request at no charge, or may be downloaded from our website, [www.drainbrain.com](http://www.drainbrain.com). Instructional videos are available for download on our website, and may be ordered. If you have any questions or problems, please call General's customer service department at 412-771-6300.

**SAVE THESE INSTRUCTIONS!**

These instructions are intended to familiarize all personnel with the safe operation and maintenance procedures for The Metro.

**SAFETY SYMBOLS**



This is the safety alert symbol. It is used to alert you to potential personal injury hazards. Obey all safety messages that follow this symbol to avoid possible injury or death.

**DANGER**

DANGER indicates a hazard with a high level of risk which, if not avoided, will result in death or serious injury.

**WARNING**

WARNING indicates a hazard with a medium level of risk which, if not avoided, could result in death or serious injury.

**CAUTION**

CAUTION indicates a hazard with a low level of risk which, if not avoided, will result in minor or moderate injury.

**WARNING**



Electric shock resulting in death can occur if you plug this machine into an improperly wired outlet. If the ground wire is electrified, you can be electrocuted by just touching the machine, even when the power switch is off. A ground fault circuit interrupter will not protect you in this situation. Use a UL approved tester to determine if the outlet is safe.



Do not operate power tools in explosive atmospheres, such as in the presence of flammable liquids, gases, or dust. Power tools create sparks which may ignite the dust or fumes.



Only wear leather gloves. Never use any other type of glove, such as cloth, rubber, or coated gloves. Never grasp a rotating cable with a rag. These items could become wrapped around the cable and cause serious injury.



Always wear safety glasses and rubber soled, non-slip shoes. Use of this safety equipment may prevent serious injury.



Never operate machine with belt guard removed. Fingers can get caught between belt and pulley.



Do not overstress cables. Overstressing cables may cause twisting, kinking, or breaking of the cable and may result in serious injury.

## GENERAL SAFETY RULES

### WARNING

Read and understand all instructions. Failure to follow all instructions listed below may result in electric shock, fire, and/or serious injury.

#### SAVE THESE INSTRUCTIONS!

### Work Area

1. **Keep work area clean and well lit.** Cluttered benches and dark areas invite accidents.
2. **Do not operate power tools in explosive atmospheres, such as in the presence of flammable liquids, gases, or dust.** Power tools create sparks which may ignite the dust or fumes.
3. **Keep bystanders, children, and visitors away while operating a power tool.** Distractions can cause you to lose control.

### Electrical Safety

1. **Grounded tools must be plugged into an outlet, properly installed and grounded in accordance with all codes and ordinances. Never remove the grounding prong or modify the plug in any way. Do not use any adapter plugs. Check with a qualified electrician if you are in doubt as to whether the outlet is properly grounded.** If the tool should electrically malfunction or break down, grounding provides a low resistance path to carry electricity away from the user.
2. **Avoid body contact with grounded surfaces such as pipes, radiators, ranges and refrigerators.** There is an increased risk of electric shock if your body is grounded.
3. **Do not expose power tools to rain or wet conditions.** Water entering a power tool will increase the risk of electric shock.
4. **Do not abuse the cord.** Never use the cord to carry the tools or pull the plug from an outlet. Keep cord away from heat, oil, sharp edges or moving parts. Replace damaged cords immediately. Damaged cords increase the risk of electric shock.
5. **When operating a power tool outside use an outdoor extension cord marked "W-A" or "W".** These cords are rated for outdoor use and reduce the risk of electric shock.
6. **Test the Ground Fault Circuit Interrupter (GFCI) provided with the power cord to insure it is operating correctly before operating machine.** Machine must have a properly functioning ground fault circuit interrupter on the power cord. GFCI reduces the risk of electric shock.
7. **Extension cords are not recommended unless they are plugged into a Ground Fault Circuit Interrupter (GFCI) found in circuit boxes or outlet receptacles.** The GFCI on the machine power cord will not prevent electric shock from the extension cords.
8. **Only use proper three-wire extension cords in good condition which have three-prong grounding plugs and three-pole receptacles which accept the tool's plug.** Use of damaged, inferior, or other extension cords will not ground the tool. Increases the risk of electric shock and bodily injury or death.
9. **Keep all electric connections dry and off the ground.** Reduces the risk of electric shock.
10. **DO NOT touch plugs or tools with wet hands.** Reduces the risk of electric shock.

### Personal Safety

1. **Stay alert, watch what you are doing and use common sense when operating a power tool. Do not use tool while tired or under the influence of drugs, alcohol, or medication.** A moment of inattention while operating power tools may result in serious personal injury.
2. **Dress properly. Do not wear loose clothing or jewelry. Contain long hair. Keep your hair, clothing, and gloves away from moving parts.** Loose clothes, jewelry, or long hair can be caught in moving parts.
3. **Avoid accidental starting. Be sure switch is off before plugging in.** Carrying tools with your finger on the switch, or plugging in tools that have the switch on invites accidents.
4. **Remove adjusting keys or wrenches before turning the tool on.** A wrench or key that is left attached to a rotating part of the tool may result in personal injury.
5. **Do not overreach. Keep proper footing and balance at all times.** Proper footing and balance enables better control of the tool in unexpected situations.
6. **Use safety equipment. Always wear eye protection.** Dust mask, non-skid safety shoes, hard hat, or hearing protection must be used for appropriate conditions.

### Tool Use and Care

1. **Use clamps or other practical way to secure and support the workpiece to a stable platform.** Holding the work by hand or against your body is unstable and may lead to loss of control.
2. **Do not force tool. Use the correct tool for your application.** The correct tool will do the job better and safer at the rate for which it is designed.
3. **Do not use tool if switch does not turn it on or off.** Any tool that cannot be controlled with the switch is dangerous and must be repaired.
4. **Disconnect the plug from the power source before making any adjustments, changing accessories, or storing the tool.** Such preventative safety measures reduce the risk of starting the tool accidentally.
5. **Store idle tools out of reach of children and other untrained persons.** Tools are dangerous in the hands of untrained users.
6. **Maintain tools with care. Keep cutting tools sharp and clean.** Properly maintained tools, with sharp cutting edges are less likely to bind and are easier to control.
7. **Check for misalignment or binding of moving parts, breakage of parts, and any other condition that may affect the tool's operation. If damaged, have the tool serviced before using.** Many accidents are caused by poorly maintained tools.
8. **Only use accessories that are recommended by the manufacturer for your model.** Accessories that may be suitable for one tool may become hazardous when used on another tool.

### Service

1. **Tool service must be performed only by qualified repair personnel.** Service or maintenance performed by unqualified repair personnel could result in a risk of injury.
2. **When servicing a tool, use only identical replacement parts. Follow instructions in the Maintenance section of this manual.** Use of unauthorized parts or failure to follow Maintenance Instructions may create a risk of electric shock or injury.

## SPECIFIC SAFETY RULES



This is the safety alert symbol. It is used to alert you to potential personal injury hazards. Obey all safety messages that follow this symbol to avoid possible injury or death.



Electric shock resulting in death can occur if you plug this machine into an improperly wired outlet. If the ground wire is electrified, you can be electrocuted by just touching the machine, even when the power switch is off. A ground fault circuit interrupter will not protect you in this situation. Use a UL approved tester to determine if the outlet is safe.



Do not overstress cables. Overstressing cables may cause twisting, kinking, or breaking of the cable and may result in serious injury.

1. **Only wear leather gloves.** Never use any other type of glove, such as cloth, rubber, or coated gloves. Never grasp a rotating cable with a rag. These items could become wrapped around the cable and cause serious injury.
2. **Never operate machine with belt guard removed.** Fingers can get caught between belt and pulley.
3. **Do not overstress cables.** Keep leather-gloved hand on the cable for control when machine is running. Overstressing cables because of an obstruction may cause twisting, kinking, or breaking of the cable and may result in serious injury.
4. **Place the machine at a distance not greater than two feet from the opening.** Greater distances can result in cable twisting or kinking.
5. **Machine is designed for ONE-PERSON operation.** Operator must control foot switch and cable.
6. **Do not operate machine in reverse (REV).** Operating machine in reverse can result in cable damage and is used only to back cutting tool out of an obstruction.
7. **Keep hands away from rotating drum.** Do not reach into drum unless machine is unplugged. Hand may be caught in the moving parts resulting in serious injury.
8. **Be careful when cleaning drains where cleaning chemicals have been used.** Avoid direct contact with skin and eyes. Drain cleaning chemicals can cause serious burns as well as damage the cable.
9. **Do not operate machine if operator or machine is standing in water.** Will increase risk of electrical shock.
10. **Wear safety glasses and rubber soled, non-slip shoes.** Use of this safety equipment may prevent serious injury.
11. **Before starting each job, check that the cable in the drum is not broken or kinked, by pulling the cable out and checking for wear or breakage.** Always replace worn out (kinked or broken) cables with genuine GENERAL replacement cables.
12. **Only use this tool in the application for which it was designed. Follow the instructions on the proper use of the machine.** Other uses or modifying the drain cleaner for other applications may increase risk of injury.

## Ground Fault Circuit Interrupter (GFCI)

Your machine is equipped with a ground fault circuit interrupter, which protects you against shock if a short circuit should occur. Check that receptacle is properly grounded. Test the GFCI before each use.

1. Plug into 120-volt receptacle.
2. Push test button. Indicator light will go out and power to machine should cut off.
3. If light does not go out when test button is pushed, **DO NOT USE THE MACHINE** until proper repairs can be made.
4. To restore power after test, push reset button. With the reset button depressed, if the machine doesn't start, stops while running, or if the operator experiences a mild shock, **DO NOT USE THE MACHINE!** Tag the machine out of service and take it to a motor repair center or return it to the factory for repairs.



**THE SECTION OF CORD BETWEEN THE WALL PLUG AND THE GFCI IS NOT IN THE PROTECTED CIRCUIT.**

## FEATURES

### Closed Drum Metro

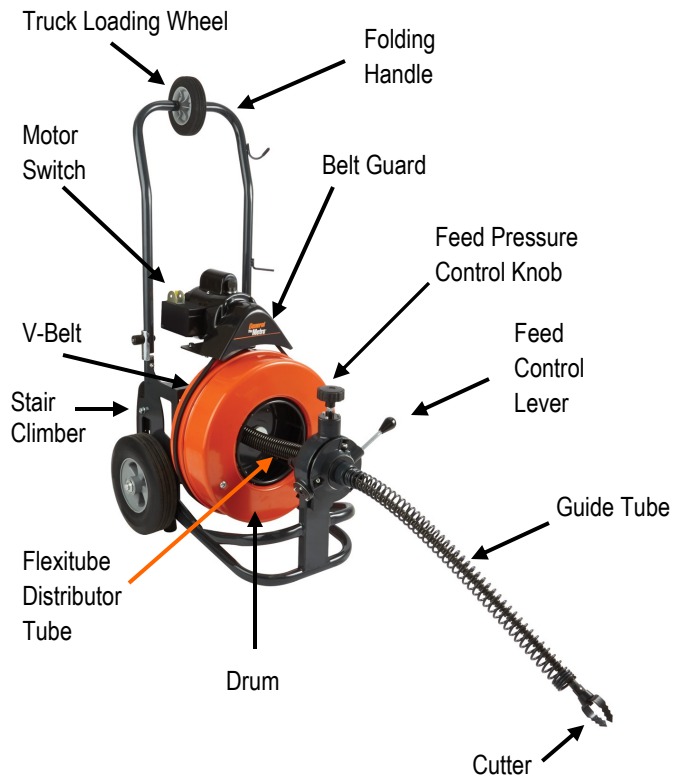

**NOTE:** Do not operate machine if warning labels on the switch box and power cord are missing or illegible.



The handle folds for compact storage.

# FEATURES

## Open Drum Metro

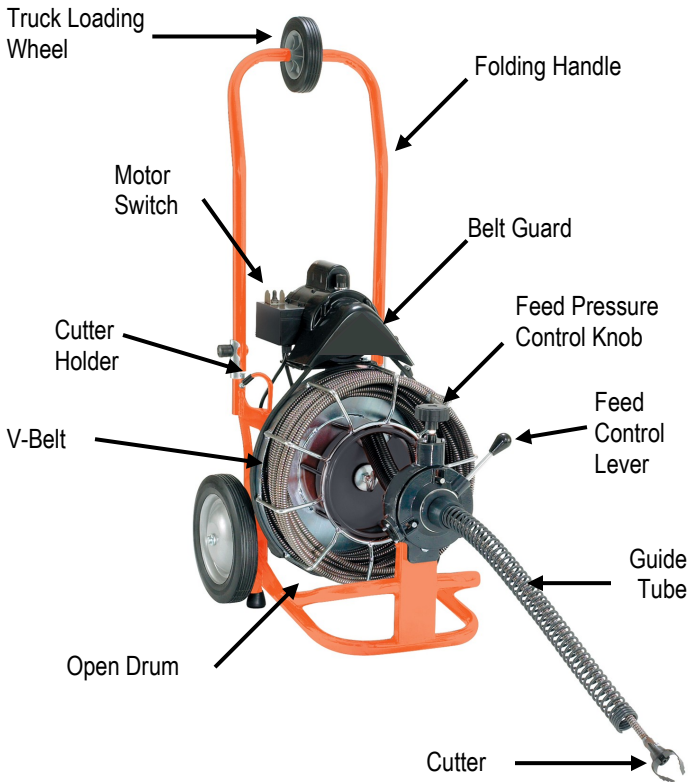

**NOTE:** Do not operate machine if warning labels on the switch box and power cord are missing or illegible.



The handle folds for compact storage.

## Cable Application Chart (Table 1)

Cable Size	Pipe Size	Typical Applications	Max. Capacity
9/16"	3" to 4"	Laundry Tubs, Roof Vents, Stacks (No roots)	100 ft.
5/8"	3" to 6"	Floor Drains, Clean Outs, Roots	75 ft.
3/4"	4" to 10"	Large Drains, Long Runs, Roots	50 ft.

## Cutter Application Chart (Table 2)

Cutter	Cat. #	Typical Applications
<b>Cutters for 9/16" Cables</b>		
Arrow Head	 AH	Starting tool, gets water flowing
1-1/2" U-Cutter	 1-1/2UC	Starting tool, to remove loose objects.
2" U-Cutter	 2UC	Starting tool, to remove loose objects.
Small Retrieving Tool	 RTR-1	To remove loose objects and broken cables.
<b>Cutters for 5/8" and 3/4" Cables</b>		
Spear Head	 SHD	Starting tool, gets water flowing
2" U-Cutter	 2UC	Starting tool, gets water flowing
3" Heavy Duty Side Cutter	 3HDSC	Finishing tool, for scraping inside edges of pipe.
3" Heavy Duty Saw Blade	 3HDB	Cutting roots and heavy stoppages.
Retrieving Tool	 RTR-2	To remove loose objects and broken cables.

### Optional Accessories for 5/8" and 3/4" Cables:

Flexible Leader	 LE3	To get through traps.
-----------------	--	-----------------------

Note: There are no fixed rules for what cutter to use. If one tool doesn't take care of a stoppage, simply try another.

# OPERATION

## Set-Up

 **MAKE SURE THE MOTOR SWITCH IS IN THE 'OFF' POSITION!**

1. Be sure the motor switch is in the **OFF** position.
2. Place machine within approximately two feet of drain opening. Be sure the Metro Guide Tube (ME-GT) is in place. If you can't place the machine this close to the drain opening, run the cable through the optional Guide Tube Extension (GTE) or a metal guide tube to prevent cable whipping. On manual feed machines, always keep a gloved hand on the cable.
3. Position the foot pedal for easy accessibility. The machine is designed for one-person operation. Be sure you can quickly remove your foot from the pedal in an emergency.
4. Make sure the Power Cable Feed is set to match the cable size you have selected. If you're using 3/4" or 5/8" cables, the feed should be assembled with the raised side of the lower two caps outward. If you are using 9/16" cable, the feed should be assembled with the raised side of the caps inward.

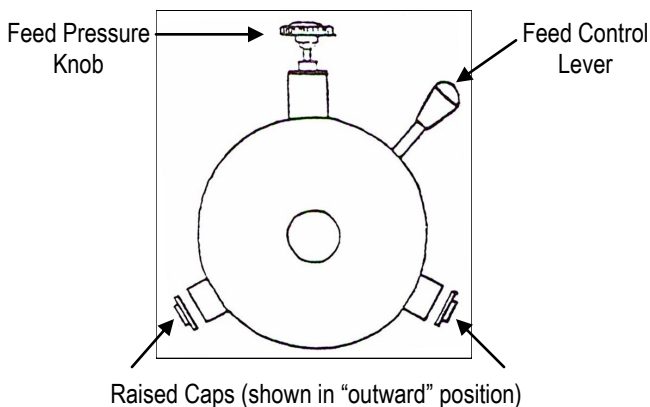

5. Select the proper cutting tool (See Cutter Application Chart—Table 2). If using 9/16" cable, a good tool to start with is the Arrow Head or 1-1/2 U-Cutter. If using 5/8" or 3/4" cable, the Spear Head or 2" U-Cutter are good starting tools. After the line is opened, follow with larger blades, which scrape the inside edges of the pipe, assuring a real cleaning job.
6. Insert the cutter into the female connector at the front of the cable and tighten the connecting screw and lock washer *firmly* in place.



## Operation

1. Before stepping on the foot pedal, pull cable from the drum and slide it into the drain as far as it will go.
2. Tighten the knob at the top of the Power Cable Feed so that the feed roller presses against the cable. Be sure not to over-tighten, since this could cause excess cable wear.
3. The feed lever controls the feeding rate and direction of the cable. Move the lever down to feed cable out of drum. The further the lever is moved downward, the faster the cable will feed out. Move lever up to retract cable into drum. When the lever is in the middle (neutral) position, cable will spin in place.

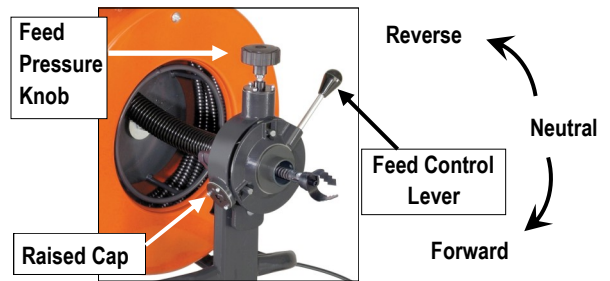

4. Move the motor switch to the **FORWARD** position.
5. With a leather-gloved hand on the Guide Tube or cable, depress the air foot pedal to start machine. Feed the cable into the line and against the obstruction with a firm, even pressure. Adjust the feeding rate to the resistance met. Do not force the cable—let the cutter do the work. The job won't go any faster and you could damage the cable.

**DO NOT USE TOO MUCH FORCE – LET THE CUTTER DO THE WORK.**

6. Don't leave too much slack in the cable since this will cause whipping. If the cable starts to bend or build up too much twist, release pressure on the foot pedal and rotate the drum in the opposite direction to relieve the twist on the cable. Push any excess cable back into the drum and then continue.

 **DO NOT ALLOW TOO MUCH SLACK IN THE CABLE BETWEEN MACHINE AND DRAIN OPENING SINCE THIS CAN CAUSE CABLE WHIPPING.**

7. If you're having trouble getting around tight bends, try putting the machine in reverse while applying steady pressure. (If using Power Cable Feed, putting motor in reverse will cause the feed control lever to operate opposite of normal.)  
Note: If your machine is equipped with a momentary contact reverse switch, you must hold the switch in position when operating the machine in reverse.

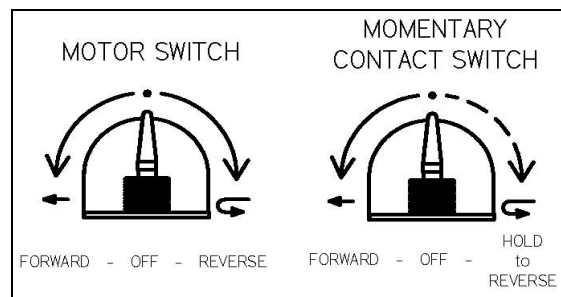

**Don't do this for more than a few seconds at a time as this could cause tangling in the drum or kinking.**

8. If you still can't get around the bend, you're probably using too large a cable. Switch to a smaller cable (See Cable Application Chart—Table 1), or use the optional flexible leader.
9. When cable reaches the stoppage, put feed into neutral. Then, allow the cable to progress forward slowly, chewing into the stoppage as it goes. This slow, forward movement will reduce stress on the cable while doing a more thorough cleaning job. A back and forth action often works best.

**Hint:** It's often helpful to have a small stream of water running in the line to wash the cuttings away while the machine is in operation and after.

10. Be careful not to let the cutter get caught in the stoppage as you work through it. This can cause kinking and breaking of the cable. When you feel the cable starting to twist in your hands, stop the machine and pull back. This will free the cutter from the obstruction. Then allow the cable to move forward slowly into the stoppage.
11. After the line has been cleared, return the cable to the drum with the motor turning **forward**. This is important to prevent the cable from tangling in the drum or in the line.
12. When the cutting tool is near the drain opening, take your foot off the pedal to stop drum rotation. Never retract the cutting tool from drain while cable is rotating. The cable could whip and cause serious injury.

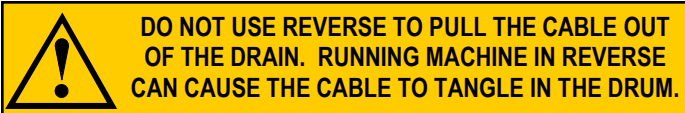

## SPECIAL OPERATIONS

### IF CABLE GETS CAUGHT IN LINE

The motor can be reversed to free the cable if it gets caught in line. (Note: if using Power Cable Feed, putting motor in reverse will cause the feed control lever to operate opposite of normal.)

1. Move motor switch to the reverse position.
2. Depress the foot pedal while retracting the cable.
3. After cable is loose, move switch back into forward position.

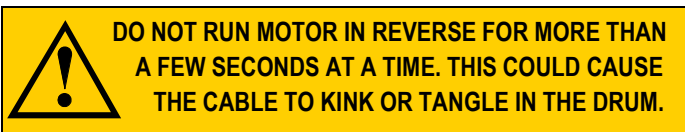

### IF CABLE TANGLES IN DRUM

This is almost always caused by using too much pressure when feeding the cable, or by feeding the cable while running the machine in reverse. To untangle, rotate drum in opposite direction. This will usually get the cable to lie in the drum properly.

If cable has become badly tangled, which will not happen when machine is used properly, it may be necessary to pull the entire cable out of the drum and re-install it. (See "How to Install Cables In Drum" section.)

## HOW TO INSTALL CABLES IN DRUM



**DISCONNECT MACHINE FROM POWER SOURCE BEFORE INSTALLING CABLES OR DRUMS!**

1. Connect the male end of cable to the drum connecting cable already attached to drum.
2. Remove V-Belt
3. Be sure the cable goes into drum as shown in the diagram or cable will tangle in drum.
4. Replace V-Belt after cable is installed.

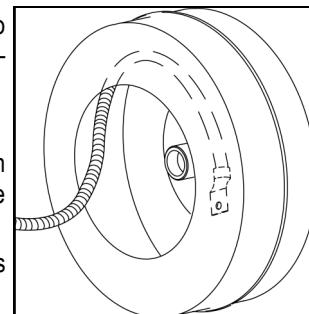

**NOTE:** The cable must lay in the drum in the correct direction or it will tangle in the drum.

## HOW TO EXCHANGE DRUMS



**DISCONNECT MACHINE FROM POWER SOURCE BEFORE INSTALLING CABLES OR DRUMS!**

1. Remove belt guard by loosening the knob above the motor.
2. Push the motor down far enough to slide V-Belt off drum.
3. Remove the cutter and connecting screw from the cable end.
4. Unscrew knob behind the front post and pull Power Cable Feed off the machine.
5. With one hand on the cable, loosen the knob on the front post cap and open the cap. The Flexitube will spring up out of the post cap. Remove the Flexitube from the cable.
6. Unscrew the drum retaining bolt in the center of drum and slide the drum off the shaft and lift it out of the way.
7. Reverse procedure to install drum.
8. To reinstall the Flexitube, pull about 12 inches of cable out beyond the frame, then guide the Flexitube, spring end first, into the front post cap.
9. Position the Flexitube so that the hole in the bushing fits over the locating pin in the base of the front post clamp. Make sure the Flexitube bushing does not protrude beyond the front post clamp.
10. From the outside of the front post, push the cable down with one hand to secure the Flexitube in position within the clamp, then close the cap and tighten the knob with the other hand.



## MAINTENANCE



**DISCONNECT MACHINE FROM POWER SOURCE BEFORE PERFORMING MAINTENANCE!**

To keep your machine operating smoothly, it is essential that all bearings be lubricated. Oiling moving parts is particularly important where machine comes in contact with sand, grit and other abrasive material.

### CABLE MAINTENANCE

To get maximum service from your cables, be sure that they are clean and well oiled. This not only provides running lubrication but greatly extends the life of the cables as well. Some users periodically pour oil directly into the drum. Then, as the drum turns, the cables get complete lubrication. Our SNAKE OIL is ideally suited for this purpose, since it not only lubricates the cables, it deodorizes them as well.



### FEED MAINTENANCE

Keep feed free of excessive soil and grit. It is recommended that the feed be flushed with fresh water followed by a light oiling of the moving parts. No disassembly is normally required. Failure to feed can usually be traced to the following possibilities:

### DIRT ACCUMULATION

Over time, dirt can harden enough to stop roller rotation. Flushing with water followed by liberal oiling can usually restore function. If disassembly is required, proceed as follows:

1. Remove the feed pressure knob, cover screws, top cover, spring, ball bearing and ball bearing holder. Note the positioning of these parts to ease re-assembly. Remove the swing pin from the carrier. The top roller assembly can now be removed.
2. Remove the end cap screws, end caps and thrust washers from the bottom housing cylinders. Remove swing pins from carriers. The bottom roller assemblies can now be removed.
3. Re-assembly is done in reverse order.

### DAMAGED ROLLER

Excessive use may wear a roller to the point of failure. It is recommended that all three rollers be replaced at the same time (Cat # PO-703). The replacement roller is an assembly consisting of one Feed Roller, two Feed Roller Bearings, and two Bearing Spacers.

**Note: The Bearing Spacers must be installed between the Carrier and each Feed Roller Bearing (as illustrated below) in order to ensure proper operation and to obtain maximum Feed Roller life.**

#### To Replace the Feed Roller Assembly:

1. Remove the Feed Roller Assembly by unscrewing and removing the Feed Roller Axle.
2. For convenience, the components are assembled and wired together at the factory. Before attempting to install the assembly, hold the assembly together and remove the wire.
3. While still holding the Feed Roller Assembly together, insert it into the slot opening of the Carrier.

4. In order to help align the Spacers and Bearings, insert a pencil point or similar object through the **un-threaded** end of the Axle hole in the Carrier. After removing the pencil point, continue to maintain the alignment of the components.
5. The Feed Roller Axle should then be inserted through the same un-threaded Axle hole and should continue to be guided through the Spacers and Bearings to the threaded Axle hole on the other side of the Carrier.
6. Securely tighten the Axle to the Carrier with a 3/16" allen wrench.

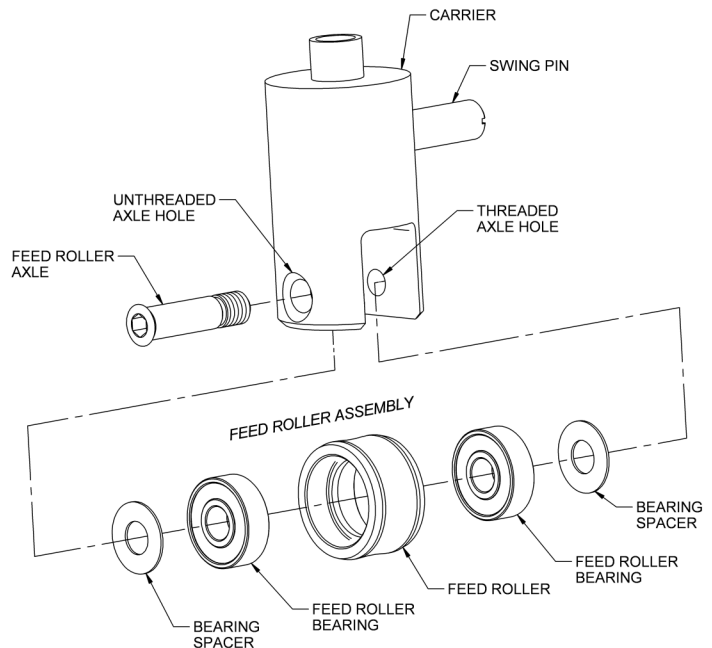

### TANGLED CABLE

If a cable loops over itself in the drum, it will not feed properly. Remove and reload the cable to restore function. If the cable kinks, it is evidence of abuse and results from the use of too much pressure or use of the wrong size cable for the line. Do not force the cable — let the cutter do the work.



**TROUBLE SHOOTING GUIDE**

<b>Problem</b>	<b>Probable Cause</b>	<b>Solution</b>
Cable kinks, tangles or breaks.	Operator forcing the cable.	Do not force cable! Let the cutter do the work.
	Too much slack between machine and drain.	Allow a distance of no more than two feet between machine and drain.
	Cable used in wrong size drain line.	A cable that is too large or too small in diameter for a line is more likely to kink. (Consult Cable Application Chart – Table 1.)
	Cable exposed to acid.	Clean and oil cables routinely.
Drum stops while pedal is depressed.	Hole in pedal or hose.	Replace damaged component.
	Hole in diaphragm switch.	If no problem found with the pedal or hose, replace the diaphragm switch.
	Thermal overload activated.	Allow motor to cool. Press reset button.
Drum turns in one direction but not the other.	Faulty reverse switch or faulty momentary contact switch.	Replace switch. Note: Momentary contact switch must be held in position to use reverse.
Ground Fault Interrupter trips and will not reset.	Damaged power cord or extension cord.	Replace cords.
	Excess moisture in area.	Remove excess moisture from area.
	Short circuit in motor.	Take motor to authorized service center. (Call General for details.)
	Faulty Ground Fault Interrupter.	Replace Ground Fault Interrupter.
Failure to feed.	Cable tangled in drum.	Do not run machine in reverse. Use proper cable size. (Consult Cable Application Chart – Table 1.)
	Feed rollers frozen.	Clean and lubricate feed rollers regularly. Replace worn rollers.
	Worn cable.	When cable coils wear flat, cable should be replaced.
Motor turns but drum does not.	Slip clutch is slipping because cable is being forced.	Do not force cable. Do not allow too much slack between the cable and the machine.
	Slip clutch is worn.	Replace slip clutch.

## THE METRO PARTS LIST ("R" Indicates for rental machine only)

CAT. NO.	DESCRIPTION	CAT. NO.	DESCRIPTION
ME-100-1	Complete Frame w/ 5/8" Axle & 10" Mag Wheels	ME-602	V-Belt Pulley (1-1/2" for 9/16" Cable)
ME-100-1-R	Complete Frame w/ 5/8" Axle & 10" Mag Wheels	ME-602-2	V-Belt Pulley (2" for 5/8" & 3/4" Cables)
ME-101-1	Frame Only for 5/8" Axle & 10" Mag Wheels	ME-602-R	Slip Clutch
ME-101-1-R	Frame Only for 5/8" Axle & 10" Mag Wheels	ME-603	Motor Support Bolts, Nuts, Washers
ME-101-A	Rubber Leg Tips (2)	GFI-20	20' Power Cord w/GFCI
ME-101-B	Rubber Cord Wrap Tips	ME-610	Foot Switch & Reverse Switch Assembly
ME-101-C	Cutter Holder w/Screws (2) & Washers (2)	ME-610-R	Foot Switch & Reverse Switch Assembly (Red Switch)
ME-101-D	Cutter Holder Screws & Washers (2)	ME-610-A	Box Only w/Cover & Screws
ME-102	Distributor Tube Clamp	ME-610-B	Foot Pedal & Hose
ME-102-A	Clamp Locking Knob	ME-610-C	Hose Clamp
ME-102-B	Clamp Screws & Washers (2)	ME-610-D	Pedal Only
ME-103	Stair Climber	ME-610-E	Power Switch Diaphragm
ME-103-A	Bolts, Nuts, Flat Washers, & Lock Washers (2)	ME-610-F	Air Hose
ME-103-B	Plastic Spacers (2)	ME-610-G	Reverse Switch (3-Way)
ME-104	Guide Tube Holder	ME-610-G-R	Momentary Contact Reverse Switch (Red)
ME-105	Hinge	ME-610-K	Switch Guard
ME-105-A	Hinge Bolts & Nuts (2)	ME-610-N	Strain Relief Nut
ME-106	Handle Locking Knobs (2)	ME-615	Belt Guard
ME-107	Handles	ME-616	Knob for Belt Guard
ME-107-R	Handles	ME-617	Belt Guard Washer
ME-107-A	Left Handle	ME-7000	Power Feed Cable Assembly
ME-107-A-R	Left Handle	ME-7000-R	Power Feed Cable Assembly
ME-107-B	Right Handle	ME-7101-1	Feed Body for One Piece Feed Control Disk
ME-107-B-R	Right Handle	ME-7101-A	Lifting Spring
ME-107-C	Handle Wheel	ME-7101-B	Guide Pins (2)
ME-107-D	Handle Wheel Axle	ME-7102	Mounting Stud
ME-107-E	Felt Washers (2)	ME-7103	Mounting Knob
ME-107-F	Set Screws (2)	ME-7104-1	Spout for One Piece Feed Control Disk
ME-110-1	10" Mag Wheel w/Cap	ME-7105	Steel Washer
ME-111-1	10" Mag Wheel Retainer Cap (2)	ME-7200	Top Roller Assembly
ME-112-1	10" Mag Wheel Spacer (2)	ME-7200-R	Top Roller Assembly
ME-115	Drum Shaft	ME-7210	Top Carrier Only
ME-116	Thrust Bearing	ME-7220	Top Swing Pin
ME-120	Motor Support w/Bolts, Nuts, & Washers	ME-7220-R	Top Swing Pin
ME-120-A	Guide Screws (2)	ME-7225	Feed Roller Shaft
ME-125	Motor Support Spring	ME-7250	Feed Roller w/Bearing
ME-200	Flexitube Distributor Tube Assembly	ME-7301	Feed Pressure Knob
ME-400	Drum Complete	ME-7301-A	Limiting Nut
ME-400-R	Open Drum Complete	ME-7315	Pressure Spring
ME-402	Drum Shell	ME-7330	Ball Bearing
ME-402-R	Open Drum Shell	ME-7331	Ball Bearing Holder
ME-405	Drum Bearings (2)	ME-7340	Top Cover Plate
ME-408	Drum Bushing	ME-7341	Plate Screws (3)
ME-409	Inner Drum Cage	ME-7400	Bottom Roller Assembly
ME-409-R	Inner Drum Cage	ME-7400-R	Bottom Roller Assembly
ME-410	Drum Connecting Cable	ME-7410	Bottom Carrier Only
ME-410-A	Nut, Bolt & Washer	ME-7420	Swing Pin
ME-410-R	Drum Connecting Cable	ME-7420-R	Swing Pin
ME-410-A-R	Nut & Washer	ME-7425	Bottom Roller Shaft
ME-425	Drum Retaining Bolt w/Grease Fitting	ME-7450	Bottom Feed Roller w/Bearing
ME-426	Retaining Washer	ME-7530	Thrust Bearing
ME-427	Felt Washer	ME-7540	Cable Adjustment Plate
ME-428	High Collar Lock Washer	ME-7541	Plate Screws (3)
ME-600	1/3 hp Capacitor Motor w/Foot Switch, Reverse Switch & GFCI	ME-7601-1	Feed Control Disk (One Piece)
ME-600-R	1/3 hp Capacitor Motor w/Foot Switch, Momentary Contact Reverse Switch, & GFCI	ME-7635-1	Wave Washer for One Piece Feed Control Disk
ME-601	V-Belt (55" for 1-1/2" Pulley)	PO-703	Set of Feed Roller Assemblies (3)
ME-601-2	V-Belt (56" for 2" Pulley)	ME-GT	Guide Tube for Metro Rooter
ME-601-R	V-Belt (52")	GTE	Guide Tube Extension
		ME-DECAL	Set of Safety Decals
		ME-SCA	Stair Climber Assembly

# THE METRO SCHEMATIC DIAGRAM

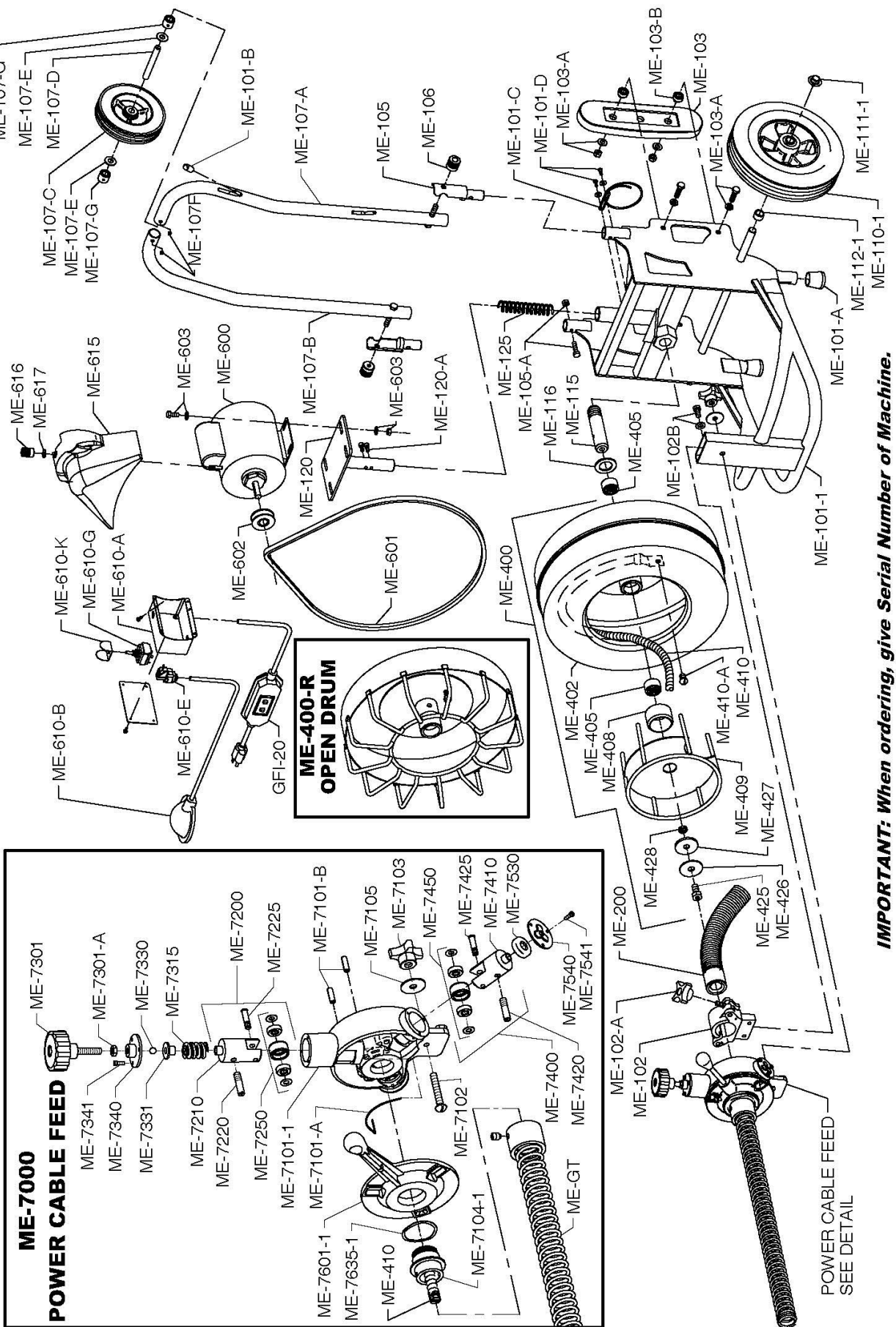

**IMPORTANT: When ordering, give Serial Number of Machine.**

**General Wire Spring Co,  
1101 Thompson Avenue  
McKees Rocks, PA 15136  
412-771-6300      [www.drainbrain.com](http://www.drainbrain.com)**