

# **Little Mike<sup>™</sup>** **Operating Instructions**

For 1-1/4" through 3" lines  
(30mm—100mm)



Your Little Mike is designed to give you years of trouble-free, profitable service. However, no machine is better than its operator.

Read, understand and follow all safety warnings and instructions provided with the product. Failure to follow the warnings and instructions may result in electric shock and/or serious injury. Save all warnings and instructions for future reference.

**SAVE THESE INSTRUCTIONS!**

***General***  
**PIPE CLEANERS**



**WARNING**

Read and understand operator's manual before using this machine. Failure to follow operating instructions could result in death or serious injury.

**WARNING!** Read and understand all instructions. Failure to follow all instructions listed below may result in electric shock, fire and/or serious personal injury. Replacement manuals are available upon request at no charge, or may be downloaded from our website, [www.drainbrain.com](http://www.drainbrain.com). Instructional videos are available for download on our website, and may be ordered. If you have any questions or problems, please call General's customer service department at 412-771-6300.

**SAVE THESE INSTRUCTIONS!**

These instructions are intended to familiarize all personnel with the safe operation and maintenance procedures for the Little Mike.

**SAFETY SYMBOLS**



This is the safety alert symbol. It is used to alert you to potential personal injury hazards. Obey all safety messages that follow this symbol to avoid possible injury or death.

**DANGER**

DANGER indicates a hazard with a high level of risk which, if not avoided, will result in death or serious injury.

**WARNING**

WARNING indicates a hazard with a medium level of risk which, if not avoided, could result in death or serious injury.

**CAUTION**

CAUTION indicates a hazard with a low level of risk which, if not avoided, will result in minor or moderate injury.

**WARNING**



Electric shock resulting in death can occur if you plug this machine into an improperly wired outlet. If the ground wire is electrified, you can be electrocuted by just touching the machine, even when the power switch is off. A ground fault circuit interrupter will not protect you in this situation. Use a UL approved tester to determine if the outlet is safe.



Do not operate power tools in explosive atmospheres, such as in the presence of flammable liquids, gases, or dust. Power tools create sparks which may ignite the dust or fumes.



Only wear leather gloves. Never use any other type of glove, such as cloth, rubber, or coated gloves. Never grasp a rotating cable with a rag. These items could become wrapped around the cable and cause serious injury.



Always wear safety glasses and rubber soled, non-slip shoes. Use of this safety equipment may prevent serious injury.

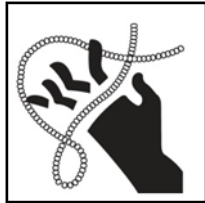

Do not overstress cables. Overstressing cables may cause twisting, kinking, or breaking of the cable and may result in serious injury.

## GENERAL SAFETY RULES

### WARNING

Read and understand all instructions. Failure to follow all instructions listed below may result in electric shock, fire, and/or serious injury.

### SAVE THESE INSTRUCTIONS!

#### Work Area

1. **Keep work area clean and well lit.** Cluttered benches and dark areas invite accidents.
2. **Do not operate power tools in explosive atmospheres, such as in the presence of flammable liquids, gases, or dust.** Power tools create sparks which may ignite the dust or fumes.
3. **Keep bystanders, children, and visitors away while operating a power tool.** Distractions can cause you to lose control.

#### Electrical Safety

1. **Grounded tools must be plugged into an outlet, properly installed and grounded in accordance with all codes and ordinances. Never remove the grounding prong or modify the plug in any way. Do not use any adapter plugs. Check with a qualified electrician if you are in doubt as to whether the outlet is properly grounded.** If the tool should electrically malfunction or break down, grounding provides a low resistance path to carry electricity away from the user.
2. **Double insulated tools are equipped with a polarized plug (one blade is wider than the other). This plug will fit a polarized outlet only one way. If the plug does not fit fully in the outlet, reverse the plug. If it still does not fit, contact a qualified electrician to install a polarized outlet. Do not change the plug in any way.** Double insulation eliminates the need for the three wire grounded power cord and grounded power supply system.
3. **Avoid body contact with grounded surfaces such as pipes, radiators, ranges and refrigerators.** There is an increased risk of electric shock if your body is grounded.
4. **Do not expose power tools to rain or wet conditions.** Water entering a power tool will increase the risk of electric shock.
5. **Do not abuse the cord. Never use the cord to carry the tools or pull the plug from an outlet. Keep cord away from heat, oil, sharp edges or moving parts. Replace damaged cords immediately.** Damaged cords increase the risk of electric shock.
6. **When operating a power tool outside use an outdoor extension cord marked "W-A" or "W".** These cords are rated for outdoor use and reduce the risk of electric shock.
7. **Extension cords are not recommended unless they are plugged into a Ground Fault Circuit Interrupter (GFCI) found in circuit boxes or outlet receptacles.**
8. **Only use proper three-wire extension cords in good condition which have three-prong grounding plugs and three-pole receptacles which accept the tool's plug.** Use of damaged, inferior, or other extension cords will not ground the tool. Increases the risk of electric shock and bodily injury or death.

9. **Keep all electric connections dry and off the ground.** Reduces the risk of electric shock.
10. **Do not touch plugs or tools with wet hands.** Reduces the risk of electric shock.

#### Personal Safety

1. **Stay alert, watch what you are doing and use common sense when operating a power tool. Do not use tool while tired or under the influence of drugs, alcohol, or medication.** A moment of inattention while operating power tools may result in serious personal injury.
2. **Dress properly. Do not wear loose clothing or jewelry. Contain long hair. Keep your hair, clothing, and gloves away from moving parts.** Loose clothes, jewelry, or long hair can be caught in moving parts.
3. **Avoid accidental starting. Be sure switch is off before plugging in.** Carrying tools with your finger on the switch or plugging in tools that have the switch on invites accidents.
4. **Remove adjusting keys or switches before turning the tool on.** A wrench or key that is left attached to a rotating part of the tool may result in personal injury.
5. **Do not overreach. Keep proper footing and balance at all times.** Proper footing and balance enables better control of the tool in unexpected situations.
6. **Use safety equipment. Always wear eye protection.** Dust mask, non-skid safety shoes, hard hat, or hearing protection must be used for appropriate conditions.

#### Tool Use and Care

1. **Use clamps or other practical way to secure and support the workpiece to a stable platform.** Holding the work by hand or against your body is unstable and may lead to loss of control.
2. **Do not force tool. Use the correct tool for your application.** The correct tool will do the job better and safer at the rate for which it is designed.
3. **Do not use tool if switch does not turn it on or off.** Any tool that cannot be controlled with the switch is dangerous and must be repaired.
4. **Disconnect the plug from the power source before making any adjustments, changing accessories, or storing the tool.** Such preventative safety measures reduce the risk of starting the tool accidentally.
5. **Store idle tools out of reach of children and other untrained persons.** Tools are dangerous in the hands of untrained users.
6. **Maintain tools with care. Keep cutting tools sharp and clean.** Properly maintained tools, with sharp cutting edges are less likely to bind and are easier to control.
7. **Inspect for misalignment or binding of moving parts, breakage of parts, and any other condition that may affect the tool's operation. If damaged, have the tool serviced before using.** Many accidents are caused by poorly maintained tools.
8. **Only use accessories that are recommended by the manufacturer for your model.** Accessories that may be suitable for one tool may become hazardous when used on another tool.

**Service**

1. **Tool service must be performed only by qualified repair personnel.** Service or maintenance performed by unqualified repair personnel could result in a risk of injury.
2. **When servicing a tool, use only identical replacement parts. Follow instructions in the Maintenance section of this manual.** Use of unauthorized parts or failure to follow Maintenance Instructions may create a risk of electric shock or injury.

**SPECIFIC SAFETY RULES**



This is the safety alert symbol. It is used to alert you to potential personal injury hazards. Obey all safety messages that follow this symbol to avoid possible injury or death.



Electric shock resulting in death can occur if you plug this machine into an improperly wired outlet. If the ground wire is electrified, you can be electrocuted by just touching the machine, even when the power switch is off. A ground fault circuit interrupter will not protect you in this situation. Use a UL approved tester to determine if the outlet is safe.



Do not overstress cables. Overstressing cables may cause twisting, kinking, or breaking of the cable and may result in serious injury.

1. **Only wear leather gloves.** Never use any other type of glove, such as cloth, rubber, or coated gloves. Never grasp a rotating cable with a rag. These items could become wrapped around the cable and cause serious injury.
2. **Do not overstress cables.** Overstressing cables because of an obstruction may cause twisting, kinking, or breaking of the cable and may result in serious injury.
3. **Place the machine at a distance not greater than two feet (.6m) from drain opening.** Greater distances can result in cable twisting or kinking.
4. **Machine is designed for ONE-PERSON operation.** Operator must control trigger switch and cable.
5. **Be careful when cleaning drains where cleaning chemicals have been used.** Avoid direct contact with corrosive drain cleaners. Drain cleaning chemicals can cause serious burns, as well as damage the cable.
6. **Do not operate machine if operator or machine is standing in water.** Will increase risk of electrical shock.
7. **Wear safety glasses and rubber soled, non-slip shoes.** Use of this safety equipment may prevent serious injury.

9. **Before starting each job, check that the cable in the drum is not broken or kinked, by pulling the cable out and checking for wear or breakage.** Always replace worn out (kinked or broken) cables with genuine GENERAL replacement cables.
10. **Only use this tool in the application for which it was designed. Follow the instructions on the proper use of the machine.** Other uses or modifying the drain cleaner for other applications may increase risk of injury.

**FEATURES**

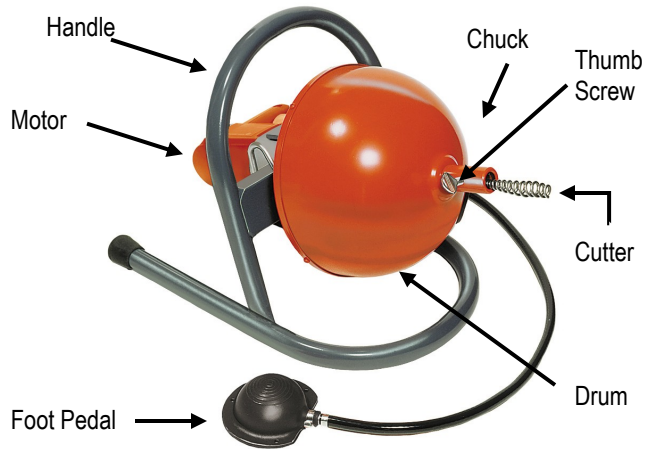

**NOTE:** Do not operate the machine if the warning labels are missing or illegible.

**VARIABLE SPEED SWITCH**

A variable speed control is built into the trigger mechanism. You can control and increase the machine's speed by applying more trigger pressure until you get the speed that you want.

You can also control the machine's direction of rotation by switching the forward and reverse lever, which is located just above the trigger switch. Move the lever toward the Forward arrow for forward rotation and toward the Back arrow for reverse rotation. Switch to OFF position when the tool is not in use.







**Cable Application Chart (Table 1)**

Cable Size	Pipe Size	Typical Applications
1/4"	1-1/4" to 2"	Small lines, tubs, and shower drains.
5/16"	1-1/2" to 2"	Sinks, basins, and small drains.
3/8"	2" to 3"	Stacks, toilets, small drains (No Roots).

*The 1/4" and 5/16" diameter cables with EL Basin plug heads can be spun through most strainer crossbars and work well in lines blocked by soft stoppages such as hair, soap, fats, etc.*

Maximum Capacity: 50 ft. of 1/4" or 5/16" cable, or 35 ft. of 3/8" cable.

Cutter Application Chart (Table 2)

Cutter	Catalog #	Typical Applications
Arrow Head 	AH	Ideal for heavy cutting and scraping.
Flexible Arrow Head 	FAH	More flexibility than Arrow Head; can take sharp turns in small lines.
Boring Gimlet 	BG	To remove or retrieve loose objects.
Down Head Boring Gimlet 	DHBG	Leads cable down drain line rather than up vent or across tee.
1-1/4" Side Cutter 	1-1/4SCB	Works well in grease stoppages, scrapes walls of pipe.
<b>Other Available Accessories:</b>		
Down Head Fitting 	DHF	Converts various cutters to the down-head style
Toilet Attachment 	CAA	For cleaning stoppages in toilet bowl

## OPERATION

### SET-UP

 **DISCONNECT MACHING FROM POWER SOURCE BEFORE ATTACHING CUTTER!**

- The cable may have an EL-Basin plug head on the end to help the cable around tight bends, or it may have a connector for attaching cutters to the end.
- To attach a cutter, first unplug the machine. Then, remove the screw and lock washer from the connector at the end of the cable. Slide the cutter into the slot, then replace the lock washer and connecting screw. Tighten the screw firmly.
- The Boring Gimlet and Arrow Head are good cutters to start with. Then change to the larger cutters after you've gotten the water flowing.
- Place machine at a distance not greater than two feet (.6 m) from the drain opening. If you can't place the machine this close to the drain opening, run the cable through a hose or pipe to prevent cable whipping.

### OPERATION

- Plug machine into a properly grounded outlet.
- Loosen the thumb screw. Hand feed the cable into the drain until you reach some resistance. Tighten the thumb screw.
- Make sure the Forward/Off/Reverse switch is in the FORWARD position.
- With both leather-gloved hands on the cable, start the machine by stepping gently on the foot pedal. The harder you press on the pedal, the faster the variable speed motor will rotate and the faster the cable will feed.

- Feed the cable carefully. Use the variable speed pedal to adjust speed as resistance is met. Don't feed faster than the cable can go into the drain. Too much cable between the power cable feed and drain will cause the cable to whip and kink.



**DO NOT ALLOW TOO MUCH SLACK IN THE CABLE BETWEEN MACHINE AND DRAIN OPENING SINCE THIS CAN CAUSE CABLE WHIPPING.**

- If the cable starts to bend or build up too much twist, take your foot off of the pedal and rotate the drum in the opposite direction to relieve the twist on the cable. Push any excess cable back into the drum and continue.
- When the cable reaches the stoppage, move the cable back and forth as the drum is rotating, until the stoppage has been cleared.
- If you're having trouble getting around bends, try putting the machine in reverse while applying steady pressure to the cable. Don't do this for more than a few seconds at a time since this could cause the cable to tangle or kink in the drum.

**DO NOT USE TOO MUCH FORCE – LET THE CUTTER DO THE WORK.**

- If you still can't get the cable around the bend, you're probably using a cable that's too large in diameter. Switch to a smaller diameter cable if necessary. (See Table 1 - Cable Application)
- After the line has been cleared, return the cable to the drum with the motor switch in the FORWARD position. This is important to prevent cable tangling in the drum.

**Hint:** It's often helpful to have a small stream of water running in the line to wash the cuttings away while the machine is in operation and after.



**DO NOT USE REVERSE TO PULL CABLE OUT OF DRAIN. ONLY USE REVERSE TO RELEASE CABLE IF CAUGHT IN LINE.**

## SPECIAL OPERATION

### IF CABLE GETS CAUGHT IN LINE

The motor can be reversed to free the cable if it gets caught in the line. Use the following procedure:

- Move the motor switch to the Reverse position.
- Tighten the chuck against the cable.
- Pull on the cable while the drum is turning in reverse.
- When the cable has been freed, move the motor switch to the FORWARD position.

**IF CABLE TANGLES IN DRUM**

**DISCONNECT MACHINE FROM POWER SOURCE BEFORE INSTALLING CABLES !**

This is caused by using too much pressure when feeding the cable or by feeding the cable while running in reverse.

1. To untangle, rotate the drum in the opposite direction to relieve the twist.
2. If the cable has become badly tangled, disassemble the drum by loosening the screws around the rim of the drum and pull the drum front off the drum. (Note: Open drum units cannot be disassembled.)
3. Pull the cable completely out of the drum. Then, reassemble the drum.
4. Straighten the cable out and push it back in the drum. (See "To Install Cable into Drum" below.)

**TO INSTALL CABLE IN DRUM**

**DISCONNECT MACHINE FROM POWER SOURCE BEFORE INSTALLING CABLES !**

1. Loosen thumb screw on the drum so that the cable can pass through easily.
2. Push the back of the cable through the spout into the drum.
3. It will be easier to load the cable if you put a slight bend in the cable about one inch from the end.

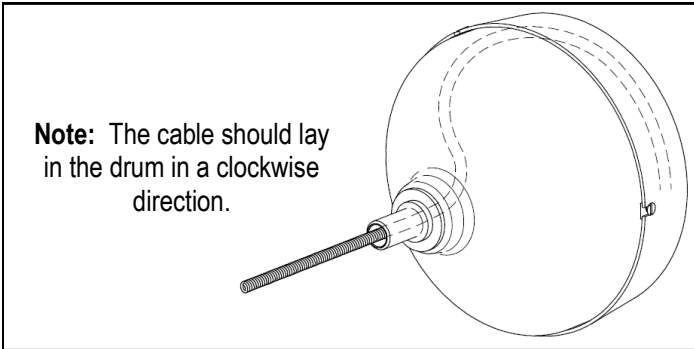

**MAINTENANCE**

**DISCONNECT MACHINE FROM POWER SOURCE BEFORE PERFORMING MAINTENANCE!**

To keep your machine operating smoothly, it is essential that all bearings and bushings be lubricated. Oiling moving parts is particularly important where machine comes in contact with sand, grit and other abrasive material.

**CABLE MAINTENANCE**

To get maximum service from your cables, be sure that they are clean and well oiled. This not only provides running lubrication but greatly extends the life of the cables as well. Some users periodically pour oil directly into the drum. Then, as the drum turns, the cables get complete lubrication. Our SNAKE OIL is ideally suited for this purpose, since it not only lubricates the cables, it deodorizes them as well.



**TROUBLE SHOOTING GUIDE (TABLE 3)**

Problem	Probable Cause	Solution
Cable kinks or breaks.	Operator forcing the cable.	Do not force the cable. Let the cutter do the work.
	Too much slack between machine and drain.	Do not allow more than two feet between machine and drain.
	Cable used in wrong size drain line.	A cable that is too large or too small in diameter for a line is more likely to kink. (Consult Table 1—Cable Applications.)
	Cable exposed to acid	Clean and oil cables regularly.
Cable tangles in drum.	Operator forcing the cable.	Do not force the cable. Let the cutter do the work.
Motor does not run.	Trigger in neutral (off) position.	Switch Trigger to either Forward or Reverse.
Motor turns in one direction but not other.	Reverse switch failure.	Replace reverse switch.

## LITTLE MIKE PARTS LIST

CAT. NO.	DESCRIPTION
LM-100-1	Frame Complete
LM-101-1	Frame Only
LM-101-1-A	Bushing
LM-101-B	Rear Bushing
LM-101-C	Bronze Tip Set Screw (2)
LM-101-D	Shaft Retaining Screw w/Lock Washer
LM-101-E	Motor Support Adjusting Screw, Washers, & Nut
LM-102	Rubber Leg Tips (2)
LM-105-1	Foam Motor Support Pad
LM-107	Nut, Bolt, & Washer for Actuator Bracket
LM-108-1	Switch Actuator Assembly
LM-108-1-A	Switch Support Bracket
LM-108-1-E	Switch Actuator w/Piston
LM-108-F	Hose
LM-108-H	Cord Clamp w/Rivet & Washer
LM-108-J	Spring
LM-108-K	Ball
LM-108-N	Nut
LM-108-P	Piston
LM-108-S	Screw & Washer
LM-115	Rubber Feet, Bolts, & Lock Nuts (2)
LM-25-1	Container Complete
LM-201	Container Front w/Spindle
LM-201	Screws (4)
LM-202-1	Container Back
LM-204	Hub w/Shaft
LM-204-A	Roll Pin
LM-205	Screws & Washers for Hub (5)
LM-206	Internal Ring Gear
LM-208	Collar w/Set Screw
LM-224	Thumbscrew
LM-300	Skil Motor Assembly
LM-304-1	Power Cord for Skil Motor
LM-310	Drive Yolk
LM-315	Reverse Thread Screw
LM-320	Variable Speed Switch for Skil Motor

# LITTLE MIKE SCHEMATIC DIAGRAM

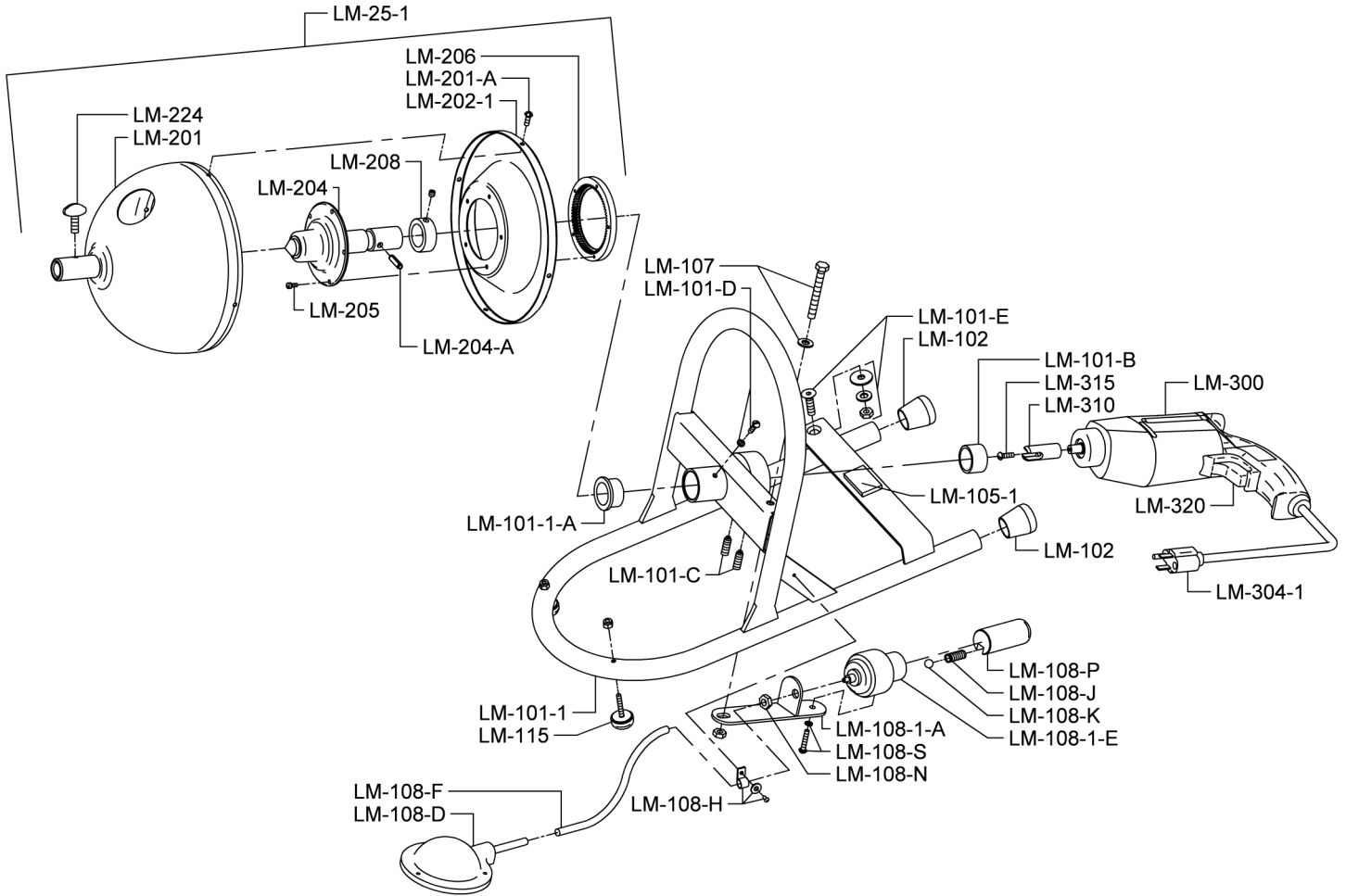

**IMPORTANT: When ordering, give Serial Number of Machine.**

Symbol	Name	Symbol	Name
V	Volts	→	Action direction or arrow
A	Amperes	~	Alternating current
Hz	Hertz	□	Designates double insulated
n <sub>o</sub>	No load speed	UL LISTED	Designates this tool is listed by Underwriters Laboratories
.../min	Revolutions per minute	SP US	Designates this tool is listed by Canadian Standards Association

**General Wire Spring Co,  
1101 Thompson Avenue  
McKees Rocks, PA 15136**

**412-771-6300      www.drainbrain.com**